

# Guide for emergency and recovery personnel

Information on responding to accidents  
involving Audi vehicles

As at: 10/2022



**Legal notice:**

This guide was created exclusively for emergency and recovery personnel who are specially trained in technical assistance after road accidents and can therefore carry out the activities described in it.

Specifications and special equipment in Audi vehicles, and the range of vehicles made by Audi AG, are subject to constant changes.

Audi therefore explicitly reserves the right to modify or change the content of this guide at any time.

The information was up to date at the time it was written.

**Please note:**

The information contained in this guide is not intended for end customers, and also not for qualified workshops and dealerships.

End customers can find information on the functions of their Audi AG vehicle, as well as important vehicle and passenger safety information, in the vehicle wallet. Workshops and dealerships receive repair information from their accustomed sources.

© Copyright, Audi AG, Ingolstadt, 2022

# Contents

|  |           |   |           |
|--|-----------|---|-----------|
| Preface . . . . .  | 5         | High-voltage service disconnect on Q5 hybrid, A6 hybrid and A8 hybrid   | 27        |
| <b>0. Rescue card(s) . . . . .</b>                                     | <b>6</b>  | Disconnecting from a charging station (manual release mechanism) . .    | 28        |
| Area of application . . . . .  | 8         | On vehicles with 48-V technology:                                       |           |
| <b>1. Identification/recognition . . . . .</b>                         | <b>12</b> | Disconnecting the 48-V battery . . . . .                                | 29        |
| Distinguishing features of Audi models . . . . .                       | 13        | Safety systems on natural gas vehicles . . . . .                        | 30        |
| Classification of electrification variants for Audi vehicles . . . . . | 14        | <b>4. Access to vehicle occupants . . . . .</b>                         | <b>32</b> |
| Distinguishing features of high-voltage vehicles . . . . .             | 15        | General instructions on behaviour at the scene of an accident . . . . . | 33        |
| Audi vehicles with a natural gas drive . . . . .                       | 18        | Body reinforcements . . . . .   | 35        |
| Distinguishing features of natural gas vehicles . . . . .              | 18        | Glazing . . . . .   | 38        |
| <b>2. Immobilisation/stabilising/lifting . . . . .</b>                 | <b>19</b> | Driver seat and steering wheel adjustment mechanisms . . . . .          | 39        |
| Preventing the vehicle from rolling away . . . . .                     | 20        | Electric convenience systems . . . . .                                  | 39        |
| Switching off the ignition . . . . .                                   | 21        | <b>5. Stored energy/fluids/gases/solids . . . . .</b>                   | <b>40</b> |
| Raising the vehicle . . . . .  | 22        | Vehicle drive energy storage unit . . . . .                             | 41        |
| <b>3. Eliminating direct hazards / safety regulations . . . . .</b>    | <b>23</b> | Vehicles with a high-voltage system . . . . .                           | 42        |
| 12-V vehicle electrical system . . . . .                               | 24        | High-voltage safety concept . . . . .                                   | 43        |
| On high-voltage vehicles:  |           | Warning labels for high-voltage components . . . . .                    | 45        |
| Cut-out connections for disabling the high-voltage system . . . . .    | 25        | The high-voltage battery . . . . .                                      | 46        |
| High-voltage cut-out connection in the engine compartment . . . . .    | 26        | Hazard warnings . . . . .   | 51        |
| High-voltage cut-out connection in the passenger compartment . . . . . | 26        | Flammable materials . . . . .   | 52        |
| High-voltage cut-out connection in the rear of the vehicle . . . . .   | 27        | Natural gas vehicles . . . . .  | 53        |
|  |           | Air conditioning system . . . . .                                       | 55        |
|  |           | Compressed air tanks . . . . .  | 55        |

Flammable materials . . . . . 55

**6. In case of fire . . . . . 56**

Vehicle fire . . . . . 57

Fire in high-voltage vehicles . . . . . 58

Fires in gas vehicles . . . . . 60

**7. Under water . . . . . 61**

Vehicle under water . . . . . 62

High-voltage vehicle under water . . . . . 62

Natural gas vehicle under water . . . . . 62

**8. Towing / transport / storage . . . . . 63**

Recovering vehicles involved in accidents . . . . . 64

Recovering high-voltage vehicles involved in accidents from  
a danger area . . . . . 64

Recovering natural gas vehicles involved in accidents from  
a danger area . . . . . 66

**9. Important additional information . . . . . 67**

Airbag . . . . . 68

Airbag stored gas inflators . . . . . 73

Seat belt pretensioners . . . . . 73

Roll bar . . . . . 77

Re-active bonnet . . . . . 78

Sources, further information . . . . . 78

**10. Explanation of the pictograms used. . . . . 79**

## Preface

The driver, the vehicle and the surroundings are the three key factors whose interaction is decisive for road safety.

The vehicle has a number of jobs to do when an accident occurs, including:

- Keeping the passenger compartment as rigid as possible to ensure space for survival
- Dissipating the impact energy using intelligent structural concepts and elements
- Using an optimised restraint system – consisting of airbags and seat belts with belt pretensioners and belt force limiters – to protect the occupants effectively
- Using safety systems to minimise the hazards from service fluids and powertrain components

Audi vehicles have been proven to be among the safest in international tests. However, accidents and the associated injuries can never be ruled out. This means a short, fast and effective chain of rescue is as essential as ever.

This guide was created in accordance with ISO 17840 and is intended to help

emergency and recovery personnel to do their jobs by providing the necessary information on the technology used in Audi vehicles.

Technical innovations such as new materials or new drive technologies require a modified approach when performing a rescue from a vehicle that has been in an accident.

The processes and procedures in the different countries around the world are usually governed by official instructions or guidelines issued by legislators, or the rescue organisation itself. If information about the procedure is provided in this guideline for rescue services, they should be considered as suggestions only for these reasons.

The information is intended in particular for the training and development of emergency and recovery personnel. Appropriate rescue cards for Audi vehicles are available for use at the scene of an accident.

The latest versions can be found at [www.audi.com/rescue](http://www.audi.com/rescue). Please bear in mind that there may be a slight delay before the guideline for rescue services is updated to reflect changes to the vehicles.

# 0. Rescue card(s)

## 0. Rescue card(s)

Audi provides rescue cards for all vehicle models and variants.

All the models of the Audi brand are listed in a model overview ([www.audi.com/rescue](http://www.audi.com/rescue)). The individual rescue cards can be downloaded directly from the model overview.

The illustration shown here includes an example of the first page of the rescue card for the Audi e-tron in accordance with ISO 17840-1:2015.

The complete, up-to date rescue card can be found at [www.audi.com/rescue](http://www.audi.com/rescue) along with all the other data sheets created by Audi.



The rescue cards for all vehicles launched since 2020 have been created in accordance with ISO 17840. The rescue cards for vehicles launched prior to this feature the manufacturer's layout.

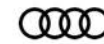

**Audi e-tron**

SUV inkl. Sportback, ab 2020

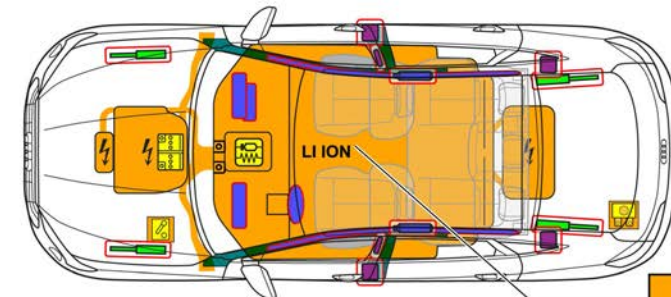

400 V  
LI ION

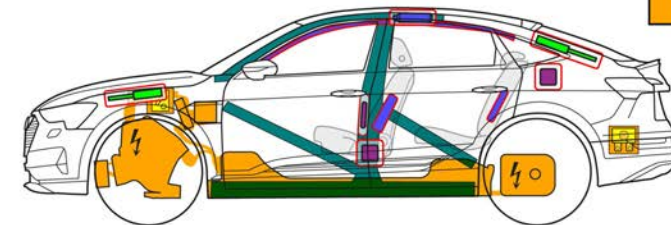

**Hinweis:** Es ist die maximal mögliche Ausstattung abgebildet.

|  |                                    |  |   |  |                         |  |   |  |                                |
|--|------------------------------------|--|---|--|-------------------------|--|---|--|--------------------------------|
|  | Airbag                             |  | Gasgenerator  |  | Gurtstraffer            |  | SRS Steuergerät                               |  | Aktives Fußgängerschutz-System |
|  | Automatisches Überrollschutzsystem |  | Gasdruckfeder / vorgespannte Feder                  |  | Hochfeste Bereiche      |  | Besondere Aufmerksamkeit                      |  |                                |
|  | Niedervolt-Batterie                |  | Niedervolt-Kondensator                              |  | Treibstofftank          |  | Gastank                                       |  | Sicherheitsventil              |
|  | Hochvolt-Batterie                  |  | Hochvolt-Leitung                                    |  | Hochvolt-Trennung       |  | Sicherungsdose, Deaktivierung Hochvolt-System |  | Hochvolt-Kondensator           |
|  | Hochvolt-Trennung an Niedervolt    |  | Sicherungsdose, Deaktivierung HV-System an Hochvolt |  | Hochspannungskomponente |  |   |  |                                |

Zusätzliche Informationen

Dokumentnummer  
rds.au\_513.001.de

Version  
06/2021

Seite  
1 von 4

## Area of application

This guide for emergency and recovery personnel is valid for all vehicles made by the Audi brand.

The diverse model portfolio – ranging from compact cars to sports cars – includes vehicles with petrol engines, diesel engines, natural gas drives, hybrid drives and fully electric drives.

Examples of the most important vehicles made by Audi are depicted on this page and on the following pages.

Information on the current Audi model range can be found on the [www.audi.com](http://www.audi.com) website.

### Current Audi model range

# A1



A1



A1 Citycarver

# A3



A3 Sportback



A3 Sportback TFSI e (high-voltage)



A3 Sportback g-tron (natural gas)



A3 Saloon



S3 Sportback

### Current Audi model range



S3 Saloon



RS 3 Sportback



RS 3 Saloon

# A4



A4 Saloon



A4 Avant



A4 Avant g-tron (natural gas)



A4 allroad quattro



S4 Saloon



S4 Avant



RS 4 Avant

# A5



A5 Coupé



A5 Sportback



0. Rescue card(s)

Current Audi model range



A5 Sportback g-tron (natural gas)



A5 Cabriolet



S5 Coupé



S5 Sportback



S5 Cabriolet



RS5 Coupé



RS5 Sportback

A6



A6 Saloon



A6 Saloon TFSI e (high-voltage)



A6 Avant



A6 Avant TFSI e (high-voltage)



A6 allroad quattro

Current Audi model range



S6 Saloon



S6 Avant



RS 6 Avant

A7



A7 Sportback



A7 Sportback TFSI e (high-voltage)



S7 Sportback



RS 7 Sportback

A8



A8



A8 L



A8 TFSI e (high-voltage)



A8 L TFSI e (high-voltage)

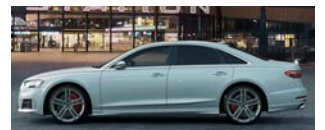

S8

0. Rescue card(s)

Current Audi model range

Q2



Q2



SQ2

Q3



Q3



Q3 TFSI e (high-voltage)



Q3 Sportback



Q3 Sportback TFSI e (high-voltage)



RS Q3



RS Q3 Sportback

Q4  
e-tron



Q4 e-tron (high-voltage)



Q4 Sportback e-tron (high-voltage)

Current Audi model range

Q5



Q5



Q5 TFSI e (high-voltage)



Q5 Sportback



Q5 Sportback TFSI e (high-voltage)



SQ5



SQ5 Sportback

Q7



Q7



Q7 TFSI e (high-voltage)



SQ7

0. Rescue card(s)

Current Audi model range

**Q8**



Q8



Q8 TFSI e (high-voltage)



SQ8



RS Q8

**e-tron**



Audi e-tron (high-voltage)



Audi e-tron Sportback (high-voltage)



Audi e-tron S (high-voltage)



Audi e-tron S Sportback (high-voltage)

**e-tron GT**



e-tron GT quattro (high-voltage)



RS e-tron GT (high-voltage)

Current Audi model range

**TT**



TT Coupé



TT Roadster



TTS Coupé



TTS Roadster



TT RS Coupé



TT RS Roadster

**R8**



R8 Coupé V10 performance



R8 Spyder V10 performance

# 1. Identification/ recognition

## Distinguishing features of Audi models

In addition to the Audi four-ring logo, the individual models can be identified by their respective body shape, body size and the individual vehicle design. The model designation and the technology lettering on the rear of the vehicle can also help with identification. This lettering is not present, however, if it was not ordered with the vehicle or has been subsequently removed. The illustrations on this page show examples of how the logo and the lettering are attached.

Information on the current Audi model range can be found on the [www.audi.com](http://www.audi.com) website.

---

### Model name



Model designation on the rear of the vehicle

---

### Audi logo



Audi logo on the radiator grille



Audi logo on the tailgate

## Classification of electrification variants for Audi vehicles

The hazards to emergency and recovery services posed by electrified vehicles following an accident are different from those presented by conventionally powered vehicles. This makes it crucial to identify these vehicles as soon as possible.

Audi offers several electrification variants that differ with regard to the primary energy source, the voltage, the type of driven machine and the electric range.

A distinction is made between the following variants without an external charging socket:

- Mild hybrid electric vehicle (MHEV)
- Full hybrid electric vehicle (HEV)

and the following variants with an external charging socket:









- Plug-in hybrid electric vehicle (PHEV)
- Battery electric vehicle (BEV)

The different electrification concepts are shown in the table.



Mild hybrid electric vehicles (MHEV) with vehicle electrical system voltages of up to 48 V are not considered high-voltage vehicles.

These vehicles also do not differ from the conventional Audi variants of the respective model in terms of their external appearance.

All the other listed variants are high-voltage vehicles.

|                               | Mild hybrid   | Full hybrid   | Plug-in hybrid  | Battery electric vehicle  |
|-------------------------------|---|---|---|---|
| <b>Voltage</b>                | 12-48 V   | 200-300 V   | 300-450 V   | 300-950 V   |
| <b>Electric motor</b>         | 10-15 kW  | 20-50 kW  | 60-120 kW   | > 150 kW  |
| <b>Electric vehicle range</b> |   | approx. 3 km  | approx. 50 km   | > 200 km  |
| <b>Energy source</b>          |   |   |    |   |
| <b>Examples</b>               | A3 A4<br>A5 A6<br>A7 A8<br>Q5 Q8  | Q5 hybrid<br>A6 hybrid<br>A8 hybrid   | A3 e-tron<br>Q7 e-tron<br>Q5 TFSI e<br>A6 TFSI e<br>A7 TFSI e<br>A8 TFSI e  | e-tron<br>e-tron Sportback<br>e-tron GT   |

### Key to energy sources

| Symbol  | Designation  |
|---|--|
|  | Conventional fuels, e.g. petrol and diesel           |
|  | Battery operation                                    |
|  | Battery operation with option of charging via socket |

## Distinguishing features of high-voltage vehicles

### 1. Features on the outside of the vehicle

- “e-tron” model designation or “TFSI e” technology lettering:  
The current Audi high-voltage vehicles can be identified by the “e-tron” model lettering (fully electric vehicles) or by the “TFSI e” technology lettering (plug-in hybrid). Earlier full hybrid models from Audi can be identified by the “hybrid” model lettering.
- External charging socket for the high-voltage battery:  
The charge port with charging socket is located either on the wing or on the rear side section. On the A3 e-tron (2014 to 2020), the charge port is integrated into the radiator grille behind the Audi rings.
- “E” designator on the number plate (only in Germany and only if the customer has ordered this feature)

### Model designation and technology lettering on high-voltage vehicles



“hybrid” lettering on the tailgate on the previous full hybrid models



The model designation and drive technology letterings differ between the models, and vehicles can be ordered without these letterings. They could also have been removed by the vehicle owners.

### Model designation and technology lettering on high-voltage vehicles



e-tron lettering on the tailgate on the current fully electric vehicles



“TFSI e” lettering on the tailgate on the current plug-in hybrid models

### Charging socket on high-voltage vehicles



“e-tron” charging socket on the wing (possible on both sides)

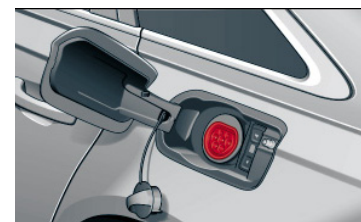

A6 “TFSI e” charging socket on the rear side section

## 1. Identification/recognition

### Charging socket on high-voltage vehicles



A3 “e-tron” charging socket (2014 to 2020)  
on the radiator grille

### Different charging sockets



Charging socket Type 1 AC (e.g. in NAR, South  
Korea, Japan)



Charging socket CHAdeMO DC (e.g. in Japan)

### Different charging sockets



Charging socket CCS2 DC and AC (e.g. in the  
EU)



Charging socket Type 2 AV (e.g. in the EU)



Charging socket CCS1 DC and AC (e.g. in NAR,  
South Korea)



## 1. Identification/recognition

### 2. Features in the engine compartment

- Orange high-voltage power cables  
All high-voltage cables and high-voltage connectors in visible areas are fitted with orange insulation. However, the cables may also be concealed under covers.
- Standard international warning label for high-voltage technology

#### Features in the engine compartment

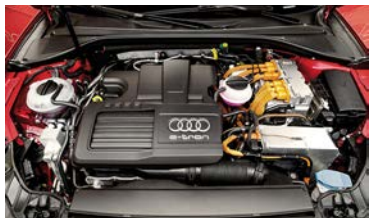

Orange high-voltage cables in the motor compartment



Warning labels

### 3. Features in the interior

- e-specific displays in the instrument cluster, such as charging displays and power meter (“READY” indicates readiness to drive)
- “EV mode” button in the centre console
- Model lettering on the dash panel

#### Features in the interior



Freely programmable digital instrument cluster with power meter and charge level indicator



“EV mode” button in the centre console



“e-tron” lettering on the dash panel

## Audi vehicles with a natural gas drive

A number of points distinguish vehicles with a natural gas drive from conventional vehicles. It is therefore important that these vehicles are correctly recognised during rescue operations, so that the hazards at the scene of the accident can be evaluated and suitable measures can be taken.

Audi offers various vehicle models with combined petrol and natural gas drives.

In addition to having several natural gas tanks, Audi natural gas vehicles are also fitted with a small petrol fuel tank.



Please do not mistake natural gas (also referred to as compressed natural gas, or CNG) for liquefied petroleum gas (LPG)! Liquefied petroleum gas and LPG systems are fundamentally different from natural gas and natural gas systems.

## Distinguishing features of natural gas vehicles

### 1. Features on the outside of the vehicle

- “g-tron” model designation or technology lettering
- External natural gas connection, integrated next to the tank filler neck

### Distinguishing features of natural gas vehicles



“g-tron” lettering on the tailgate



Natural gas connection on the tank filler neck



“g-tron” lettering in the engine compartment

## **2. Immobilisation/ stabilisation/ lifting**

### Preventing the vehicle from rolling away

Audi models are fitted with either a manual gearbox or an automatic gearbox. To prevent the vehicle from rolling away or moving accidentally, the first step is to put the gear selector lever in the “neutral” position on vehicles with a manual gearbox, or to put the selector lever in the “P” position on vehicles with an automatic gearbox. On automatic vehicles without a selector lever, the “P” button must be pressed instead.



Vehicle with an automatic gearbox with a selector lever: put the selector lever in the “P” position

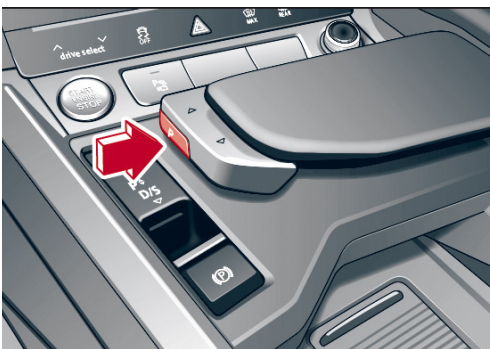

Vehicle with an automatic gearbox without a selector lever: press the “P” button



Vehicle with an automatic gearbox without a selector lever: press the “P” button

The second step is to locate and actuate the mechanical or electrical parking brake. The switch for the electrical parking brake is usually located next to or behind the shifting/selector gate and is actuated by “pulling”.



Switch for the electrical parking brake

## Switching off the ignition

On vehicles with an ignition lock, the ignition is switched off by turning the ignition key towards the vehicle occupant to “position 0”, as shown in the illustration.

Vehicles with a convenience key do not have a conventional ignition lock installed. The driver merely needs to have the ignition key on their person (Keyless Entry and Keyless Go).

The “START ENGINE STOP” button switches the ignition on or off and starts or stops the engine.

The “START ENGINE STOP” button is located in the centre console or on the dash panel.



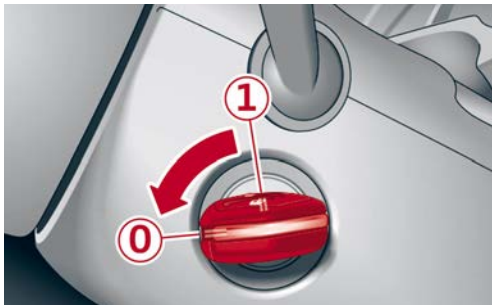



On some vehicles, the ignition is switched on as soon as the driver enters the vehicle with the key and presses the brake pedal or closes the driver’s door.



Vehicle with ignition lock





“START ENGINE STOP” button

|  |  |
|--|--|
|   | <p>On vehicles with a high-voltage drive, the electric machine is noiseless. The display in the instrument cluster (power meter) provides feedback as to whether the electric drive is “READY” or “OFF”.</p> <div style="display: flex; justify-content: space-around; align-items: center;"> <div style="text-align: center;">  <p><b>“READY”</b><br/>Drive switched on<br/>Vehicle ready to drive</p> </div> <div style="text-align: center;">  <p><b>“OFF”</b><br/>Drive switched off</p> </div> </div> |
|   | <p>When the “START ENGINE STOP” button is pressed and the brake pedal is simultaneously pressed down, the vehicle may switch to ready-to-drive mode. Observe the information in the rescue cards!</p>  |
|   | <p>On some vehicles, ready-to-drive mode is activated if a gear is engaged while the brake pedal is simultaneously pressed down.</p>   |
| <br> | <p>A key card or a smartphone app can also be used instead of a remote control key. Ensure that the remote control key, key card or smartphone is removed from the vehicle after the ignition has been switched off to prevent the ignition from being unintentionally switched on again. The remote control key, key card or smartphone should be kept a minimum of 5 m away from the vehicle.</p>  |

### Raising the vehicle

The points where the vehicle can and cannot be lifted are indicated in the rescue cards.

|   |  |
|---|--|
|  | When a vehicle has been damaged as a result of an accident, the emergency and recovery personnel on site must decide at which points to raise the vehicle. |
|  | If possible, lift the vehicle at the indicated lifting points.   |

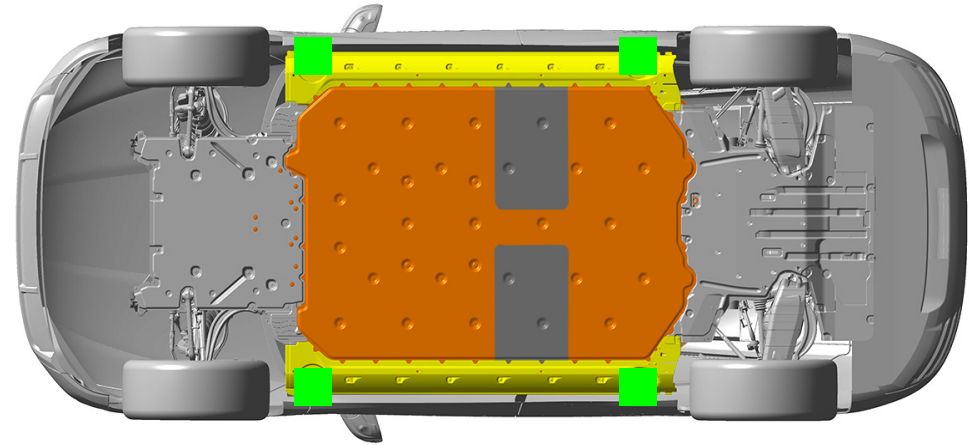

 Suitable lifting points

 High-voltage battery

Example of suitable lifting points on the Audi e-tron GT

# **3. Disable direct hazards / safety regulations**

## 12-V vehicle electrical system

The increasing number of equipment options for vehicles means that the number of energy consumers has increased, and with them the need for several energy storage units.

This also has consequences for rescue operations as, particularly when disabling the vehicle electrical system (switching off the ignition, disconnecting the vehicle batteries), additional points should be taken into consideration.

### Switching off the ignition

The procedure for “switching off the ignition” is explained in section 2, “Immobilisation/stabilisation/lifting”.

### Disconnecting the 12-V battery

Disabling the vehicle electrical system reduces not only the risk of fire caused by short circuits, but also the risk of delayed deployment of airbags, seat belt pretensioners or rollover bars.

When disabling the vehicle electrical system, it must also be ensured that the power supply to any attached trailers is disconnected and that any solar elements in the sliding sunroof are covered.



When the 12-V vehicle battery has been disconnected, all functions of the electrical system stop working (this applies in particular to the hazard warning lights and electric seat adjustment).

In addition, the information in section 4, “Access to the occupants”, and section 9, “Important additional information” must be observed.

Depending on the type of vehicle and equipment, one or more 12-V vehicle batteries may be installed.

The location of the 12-V battery or batteries can be found in the rescue card.

If the battery is to be completely disconnected, the earth terminal/negative terminal must be disconnected, as otherwise there is a risk of short circuit. The negative terminal must be protected against further contact (by insulating it, tying it up or bending it out of the way etc.). Once the battery has been disconnected, it should be checked whether the vehicle is actually de-energised. The hazard warning lights or the interior lighting going out can serve as an indicator for this.



The position(s) of the 12-V battery or batteries can be found on the rescue cards.





Batteries that have a pyrotechnic isolation element must also be disconnected to ensure that the vehicle is completely de-energised.

On vehicles with 48-V technology or high-voltage technology, in addition to disconnecting the 12-V battery, the 48-V battery must also be disconnected or the high-voltage system must also be disabled to ensure that the vehicle is completely de-energised. See the information on the following pages.







## On high-voltage vehicles: Cut-out connections for disabling the high-voltage system

|   |   |
|---|---|
|  | <p>In the event of an accident in which an airbag is deployed, the high-voltage system will be automatically disabled. The high-voltage system is de-energised and irreversibly disconnected from the high-voltage battery approximately 20 seconds after being disabled.</p> |
|  | <p>In all other cases, an emergency cut-out connection can be used to disable the high-voltage system. One major effect of using the emergency cut-out connection is that the high-voltage system cannot be switched back on.</p>   |

There are usually at least two emergency cut-out connections: one in the front of the vehicle and one in the interior or luggage compartment. This means that at least one of these should always be accessible, regardless of the accident scenario.

These emergency cut-out connections, which are marked by yellow flags, only carry the 12-V vehicle electrical system voltage and can therefore be safely disconnected by emergency personnel using the procedure described on the flags.

|   |  |
|---|--|
|  | <p>Disconnecting a marked emergency cut-out connection only disables the high-voltage system. Safety systems such as airbags or seat belt pretensioners are still supplied with voltage by the 12-V electrical system.</p> |
|---|--|

|   |  |
|---|--|
|  | <p>The positions of the emergency cut-out connections and the procedure for disabling the vehicle are shown on the Audi rescue cards.</p>  |
|  | <p>On vehicles with a high-voltage drive, the electric machine is noiseless. This is why it is particularly important to disable a high-voltage vehicle in order to prevent it from being switched on again.</p> |
|  | <p>Even after the high-voltage system has been disabled, there is still voltage inside the high-voltage battery. The high-voltage battery must therefore not be damaged or opened during rescue operations.</p>  |
|  | <p>Do not touch damaged high-voltage components; cover them with a suitable object if necessary! Wear personal protective equipment in accordance with the local standards!</p>                                  |

## High-voltage cut-out connection in the engine compartment

The “low-voltage service disconnect” in the engine compartment serves as an emergency cut-out connection for the high-voltage system in plug-in hybrid electric vehicles (PHEV) and battery electric vehicles (BEV). The connector has a green housing and can be unlocked via a tab. A yellow label on the connector cable clearly identifies the connector as an emergency cut-out connection. The connector is marked with the “high-voltage cut-out connection” symbol in the rescue card.

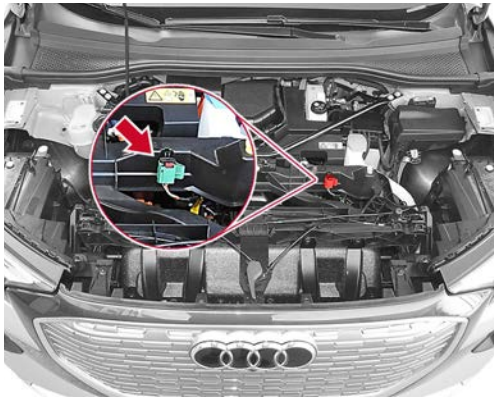

Cut-out connection in the engine compartment of the Audi Q4 e-tron

Procedure for disabling the high-voltage system via the high-voltage cut-out connection:

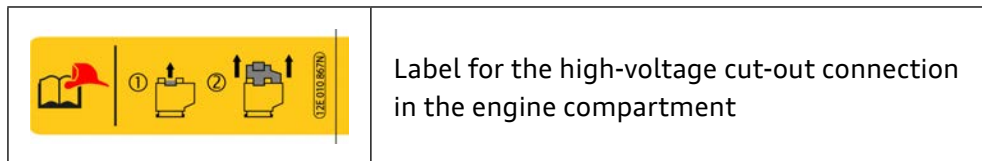
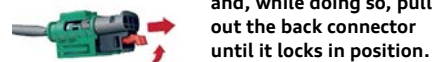

## High-voltage cut-out connection in the passenger compartment

An additional high-voltage cut-out connection is located on the fuse carrier (in the vicinity of the dash panel in the interior or in the luggage compartment); the respective fuse is marked with a yellow flag. The high-voltage system is disconnected and disabled by pulling the appropriately labelled fuse out of its holder.

Here too, the load contactors in the high-voltage battery subsequently open and disconnect it from the rest of the high-voltage system, which is then de-energised after 20 seconds have passed.



Cut-out connection in the passenger compartment, on the fuse carrier in the dash panel

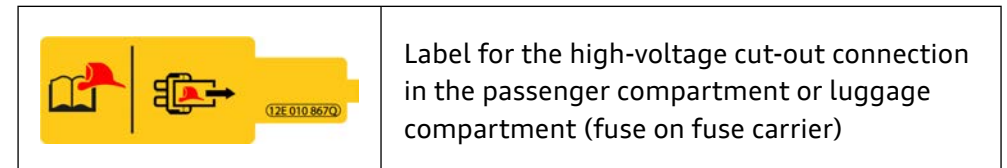

## High-voltage cut-out connection in the rear of the vehicle

On some models, there is an additional cut-out connection in the rear area. In this case, a cable, labelled with a yellow flag, must be cut.

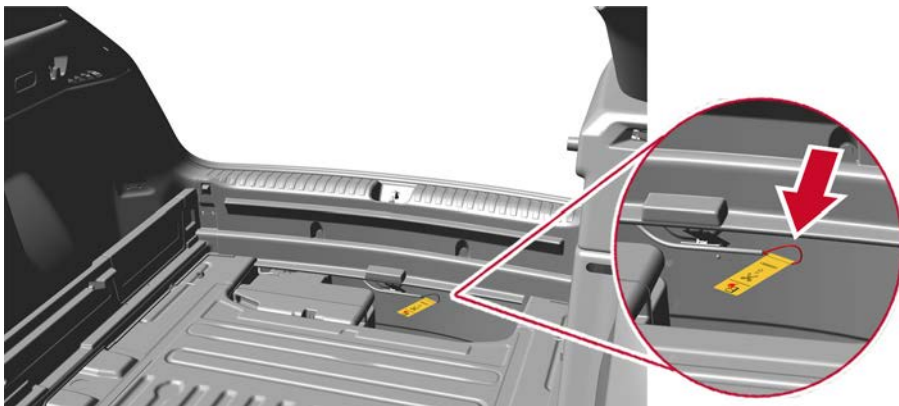

Cut-out connection in the luggage compartment of the Q4 e-tron, under the boot floor at the rear end. The yellow flag indicates the cut-out connection.

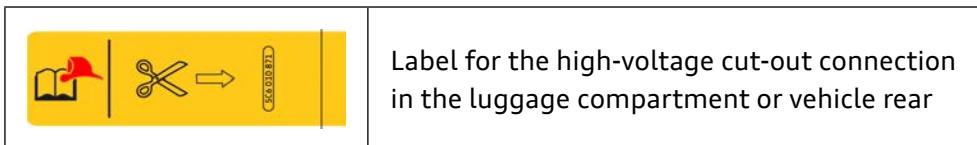

## High-voltage service disconnect on Q5 hybrid, A6 hybrid and A8 hybrid

The hybrid electric vehicles (HEV) Q5 hybrid (2011–2016), A6 hybrid (2012–2015) and A8 hybrid (2012–2017) have a different type of connector for the high-voltage service disconnect.

This high-voltage service disconnect connector is located in the centre of the boot under a flap that needs to be opened. The orange rubber protective cap underneath this flap must be removed. The exact position is indicated in the rescue cards.

The illustrations show how to directly operate this high-voltage service disconnect connector. Firstly, the lever is pulled backwards, and then it is folded upwards and pulled up and out.



Pull the lever backwards





Fold the lever upwards and pull the connector up and out.

## Disconnecting from a charging station (manual release mechanism)



High-voltage vehicles are usually charged while parked. The charging stations may be located at public car parks, in private carports/garages or at public charging columns or charging devices.

The characteristics of the respective infrastructure must be taken into account by emergency and recovery personnel called out to emergencies and fires when assessing the situation and deciding which measures to take.



|   |  |
|---|--|
|  | Public charging stations are usually connected to the public power grid at more than 1,000 volts. In the event of a fire, greater safety distances therefore need to be maintained here accordingly. |
|  | The procedure for operating the manual release mechanism for the charging connector on the vehicle is described in the rescue cards.   |

Another difference is the type of charging voltage. Some systems charge with alternating current while others charge with direct current. A system that uses direct voltage (DC) supplies the battery directly using the charging connection. If the high-voltage battery is charged with alternating current (AC), the charger in the vehicle takes on the function of the voltage converter.

|   |   |
|---|---|
|   | Observe the existing regional and national contingency plans for emergency and recovery personnel for public charging stations.       |
|  | The charging connections and the appearance of public and private charging stations differ depending on the manufacturer and country. |

## On vehicles with 48-V technology: Disconnecting the 48-V battery

Today's vehicles feature intelligent drive systems and a variety of driver assist systems. Depending on the model type and equipment, in addition to the 12-V electrical system, these vehicles are operated with an additionally installed 48-V vehicle electrical system with a lithium-ion battery.

A number of examples of use are:

- Roll stabilisation
- Advanced start/stop mode that uses a belt-driven starter-alternator

These vehicles fall under the mild hybrid electric vehicle (MHEV) category. Mild hybrid electric vehicles with vehicle electrical system voltages of up to 48 V are not considered high-voltage vehicles.



|   |   |
|---|---|
|  | In the event of accidents involving triggering of the airbag, the 48-V electrical system is automatically disabled. |
|---|---|

In all other cases, in order to ensure that the entire vehicle electrical system is disabled, the 48-V lithium-ion battery must be disconnected in addition to the 12-V lead battery.

|   |  |
|---|--|
|  | The ignition must be switched off before the batteries are disconnected. |
|---|--|

To minimise the risk of an electric arc occurring, the following procedure is recommended:

Once the batteries have been located (see rescue card), the first step is to disconnect the negative terminal of the 12-V lead battery. Only after this is done must the lithium-ion battery then be disconnected in the second step. When carrying out this procedure, it is recommended to remove the communications connector before disconnecting the negative terminal.

|   |  |
|---|--|
|  | When disconnecting the 48-V battery, there is danger of an electric arc occurring.<br>Wear suitable personal protective equipment! |
|  | Vehicles with 48-V technology do not differ from the 12-V variants of the respective model in terms of their external appearance.  |
|  | The installation position of the 48-V battery and the procedure for disconnecting it is described in the rescue cards.             |

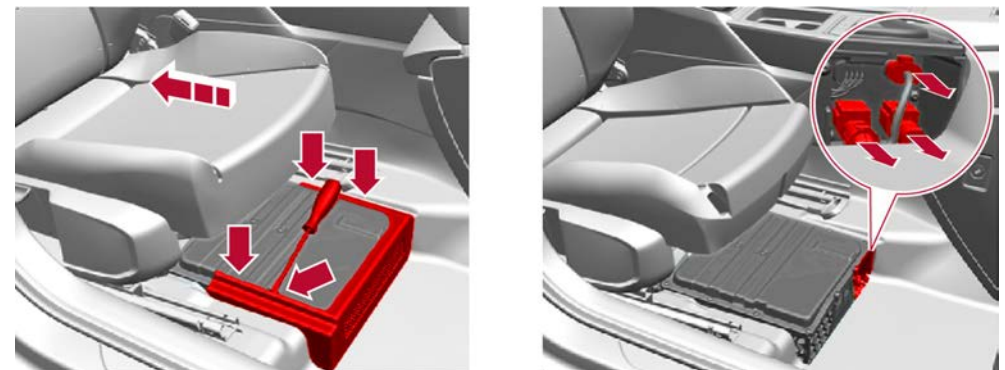

Disconnecting the 48-V vehicle electrical system on the Audi A3 Sportback

## Safety systems on natural gas vehicles

A number of points distinguish vehicles with a natural gas drive from petrol or diesel vehicles.

It is important for emergency personnel to be aware of these differences.

On Audi natural gas vehicles, the combustion engine can be operated with natural gas or also with petrol.

The natural gas tanks on the Audi g-tron models are installed on the underside of the vehicle at the rear and are partially covered by trims.

### Fuel tank shut-off valve

The fuel tank shut-off valve is an electromagnetic valve and is opened by the engine control unit during natural gas operation. The valve closes automatically when the engine is not running, in petrol mode, in the event of a loss of power supply or in the event of a crash with the seat belt pretensioner and/or airbag triggering.

Along with the electromagnetic shut-off valves, the cylinder valves have an integrated thermal fuse and a flow rate limiter that prevents the uncontrolled escape of gas if any damage to the pipes occurs. A non-return valve is also installed in the refuelling line to the gas tanks. This prevents gas from flowing back out of the cylinder and into the filler line.

### Manual shut-off valve

The manual shut-off valve allows you to close the natural gas tank manually using a standard tool to make it gas-tight.

The connection to the drainage channel for the thermal release is also open when the manual shut-off valve is closed for safety reasons.



The electromagnetic tank shut-off valves automatically interrupt the gas supply when the engine is not running, in petrol mode or in the event of a crash.

Remove the tank covers on the underbody



The tank covers are marked in green in this illustration.

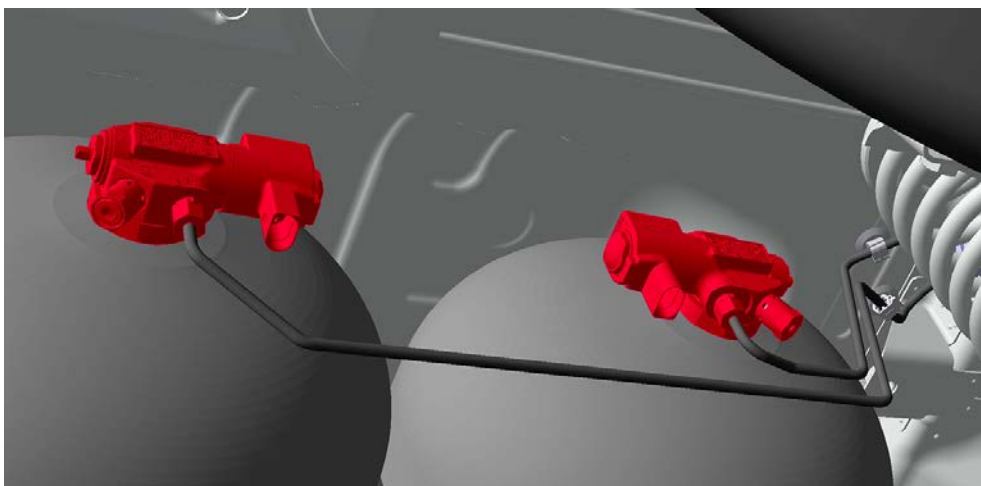

### 3. Disable direct hazards / safety regulations

Localise the gas tank shut-off valves



Turn the shut-off valve clockwise as far as it will go using a size 5 open-end spanner or pliers, or a special tool.



|   |  |
|---|--|
|  | The procedure required for manual shut-off of the gas tanks is described in the Audi rescue cards. |
|  | Labelling of the CNG gas tanks in the rescue cards.  |
|  | Labelling of the CNG shut-off valves in the rescue cards.  |

# 4. Access to the occupants



### General instructions on behaviour at the scene of an accident

#### Keep your distance

The deployment areas of safety systems that have not triggered should be kept clear of people and equipment. This particularly applies when heavy rescue equipment is in use or cable connections are being cut. During this time, neither persons nor tools should be located in areas that may be impacted by a triggered airbag.

Provided that it is medically acceptable, persons requiring treatment following an accident should also be moved out of these areas. Where seat belt pretensioners have not triggered, fastened seat belts should be cut or unfastened. If rollover bars are present and have not triggered, their deployment areas should also be kept clear.

#### Inspect the interior



To determine the status of the safety systems, the vehicle interior must be investigated at the start of the rescue work.

All airbag modules are labelled "AIRBAG". This labelling is usually located on or close to the airbag module.

For side airbags that are installed in the seat backrests, the labelling may also be present on a flag that is sewn into the seat backrest cover. For curtain airbags, multiple labels can often be found in the upper section of the vehicle pillars or along the roof pillar.

Seat belt pretensioners, if present, are not labelled. The rollover bar is only used on convertibles, where it is installed behind the rear head restraints. The cover of the rollover bar is labelled with the inscription "do not cover".

|   |   |
|---|---|
|  | <p>All possible configurations of airbags, seat belt pretensioners and rollover bar systems (where applicable) are specified in the rescue cards.</p> |
|---|---|

|   |   |
|---|---|
|  | <p>Labels for side airbags may be concealed by the seat belt or by protective covers.</p>                               |
|  | <p>The installation locations of the seat belt pretensioners and the rollover bar can be found in the rescue cards.</p> |

#### Warn rescue personnel



All emergency personnel deployed at the scene of an accident involving a vehicle should be immediately informed about the type and status of the safety systems encountered.

Only by doing so can it be ensured that all the necessary safety regulations are adhered to during the rescue work.

#### Battery management

The majority of Audi vehicles are fitted with electrical ignition systems for the airbag and for the seat belt pretensioners. Electrical activation of the airbags by the control unit for safety systems is not possible in the event of an interrupted power supply. The vehicle involved in the accident should therefore be de-energised in order to disable the safety systems.

The procedure for switching off the engine or drive and disabling/disconnecting the batteries is described in sections 2 and 3.

|   |   |
|---|---|
|  | <p>The location of the batteries can be found in the rescue cards.</p>  |
|  | <p>After the 12-V battery is disconnected, all electrical functions (lights, hazard warning lights, electrical seat/steering column adjustment etc.) are inoperative. Before disconnecting, it must be ensured that these functions are no longer required.</p> |

## 4. Access to the occupants

### Remove interior trim

Irrespective of their design, untriggered stored gas inflators for airbags and untriggered seat belt pretensioners should not be damaged.

This is particularly important to observe when removing the roof, especially when separating the vehicle pillars or when cutting through the B-pillar in the lower section.

In order to ensure that seat belt pretensioners and stored gas inflators are not damaged, the following options are recommended:

- Remove the interior trim:  
Before cutting through the vehicle pillars, the interior trim should be removed in the area to be cut. Any stored gas inflators or seat belt pretensioners that are present then become visible and the cutting line can be selected to avoid damage. Stored gas inflators for curtain airbags in Audi vehicles are arranged so that they are mirror images of each other. If the installation location on one side of the vehicle is known, the stored gas inflator on the other side of the vehicle is located in the same position.
- Check the installation position using the rescue cards:  
The information shown on the rescue cards includes the installation position of stored gas inflators and seat belt pretensioners. The use of rescue equipment can therefore be planned to avoid damaging these components.

### Hazards of airbag components

#### Triggered airbags, seat belt pretensioners and rollover bar

If a triggered airbag is causing an obstruction, this can be pushed out of the way or, if necessary, cut off. The dust that escapes when the airbag is triggered and when the airbag is compressed can cause slight irritation of the mucous membranes and the skin. The vehicle interior should be ventilated as much as possible. It is advisable to wear protective gloves/protective eyewear. As a precautionary measure, unprotected areas of skin should be washed with water once the work is complete. Since the area around the stored gas inflator can remain hot for some time, people inside the vehicle should not rest on a triggered airbag module.

#### Untriggered airbags, seat belt pretensioners and rollover bar

Do not damage the stored gas inflators of airbags that have not triggered. Do not cut into airbag modules.

- Avoid damaging the control unit for safety systems during rescue work. The location of the control unit can be found in the rescue cards. The control unit is usually located on the centre tunnel in the area of the gear lever.
- Do not place any objects on untriggered airbag modules or an untriggered rollover bar.
- Avoid exposing airbag modules to heat, e.g. through the use of flame cutting equipment. The stored gas inflator in the airbag has an auto-ignition temperature of approx. 200 °C. In burning vehicles, the airbags therefore trigger after prolonged exposure to heat.
- Wherever possible, do not damage untriggered seat belt pretensioners.
- Exercise caution when tilting or lifting the vehicle if the ignition is switched on and the battery is connected. This can cause an untriggered rollover bar to be activated, if present.



Section 9, “Important additional information”, outlines which safety systems (airbags, seat belt pretensioners, rollover bar, active pedestrian protection) are installed in current vehicles.

### Body reinforcements

A high level of safety for vehicle occupants is ensured by the rigid design of the passenger compartment in particular.

Extra-high-strength and hot-formed steels, thicker walls and a multi-shell structure are used in vehicle body construction. These are the primary areas to avoid when rescuing occupants of modern vehicles involved in an accident; however, if they do need to be opened, this will require sufficiently powerful cutting equipment.

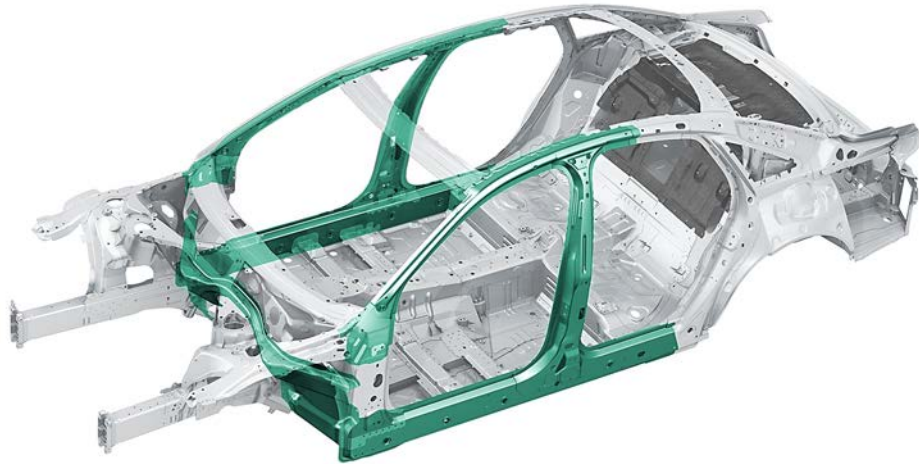

Body with reinforced passenger compartment



Labelling of high-strength areas in the rescue cards.

### The side members

In modern vehicles, special steels are used to reinforce the side members. These increase safety in the event of side collisions, especially if the vehicle hits a pole.



Hot-formed steel can only be cut using high-power cutting tools.



Information on the position of reinforcements can be found in the rescue cards for the specific vehicle.

## 4. Access to the occupants

### The A-pillar

Convertibles in particular have an additionally reinforced body in order to achieve the necessary rigidity even without a roof. Reinforcing tubes may be fitted at various positions in the vehicle including the A-pillar in order, together with the roll bars, to optimise the protected area if the vehicle overturns. It may also be possible to open the convertible roof (which is usually a fabric roof) by conventional means or by pushing up the roof with a ram.



A-pillar reinforcement in cabriolets



Cutting through the A-pillar near the A-pillar reinforcement is only possible using powerful rescue equipment.



The position of special reinforcements in individual vehicles can be found in their rescue cards.

### The B-pillar

The B-pillar is reinforced using extra-high-strength and hot-formed sheet metal combined with a multi-shell structure. In addition, modern B-pillars have a larger cross-section.

The B-pillar is additionally reinforced by the belt height adjuster around the belt guide, which makes it more difficult to cut. These areas should therefore be deliberately avoided.



B-pillar with multi-shell structure



The easiest point to cut through vehicle pillars is the area above the belt height adjuster. The lower section of the pillar can also be cut. However, bear in mind that this part of the pillar has a very large cross-section and usually contains the seat belt pretensioner.

## 4. Access to the occupants

### Side impact protection

Side impact protection is installed in the doors. The tubes or sections are arranged horizontally or diagonally behind the outer door panels.

The high-strength sections can be cut through with powerful cutting equipment.

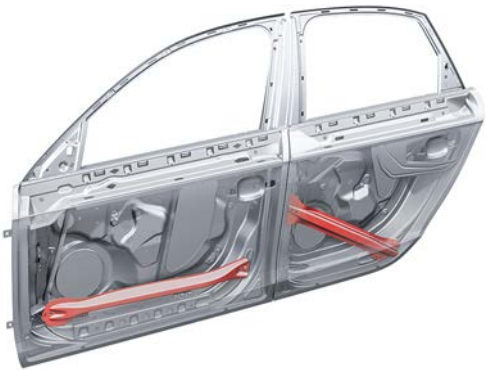

Side impact protection in the doors



The position of special reinforcements in individual vehicles can be found in their rescue cards.

## Glazing

The windows in Audi vehicles are made of toughened or laminated safety glass. The windscreen is made of laminated safety glass and the side windows, rear windows and panoramic roof are made of toughened safety glass. As an option, the side and rear windows may also be made of laminated safety glass.

### Toughened safety glass

Toughened safety glass is thermally tempered glass that can withstand high loads. When broken it crumbles into small granular pieces. Toughened safety glass is used for side windows, rear windows, tilting/sliding sunroofs and panoramic roofs.

|   |   |
|---|---|
|  | <p>Intact windows can suddenly burst during rescue work at the vehicle. Depending on the accident situation and the scope of emergency work, the windows should be removed first.</p> <p>Windows can be removed by concentrated impact using an automatic punch or an emergency hammer, for example. The windows should first be secured.</p> |
|---|---|

### Laminated glass

Laminated glass consists of two panes of glass with a layer of film in between. The glass remains largely intact when damaged. It is used for windscreens and sometimes for side windows. The windscreens are bonded to the body with adhesive.



|   |  |
|---|--|
|  | <p>Because laminated windscreens cannot suddenly burst, they only have to be removed if it is necessary for the rescue work. Laminated windows can be removed using special glass saws or metal cutting claws.</p> |
|---|--|



Toughened safety glass



Laminated safety glass

|   |  |
|---|--|
|  | <p>Protect the occupants from shards of glass before removing the panes of glass.</p>  |
|  | <p>Information about the window versions installed is also described in the respective rescue cars for more recent models.</p> |

## 4. Access to the occupants

### Driver seat and steering wheel adjustment mechanisms

The seat systems and steering columns in Audi vehicle models are operated either mechanically or electrically.



Manual steering wheel position setting



Electric steering wheel position setting

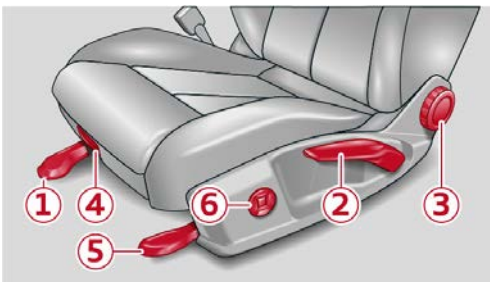

1 Longitudinal adjustment  
2 Height adjustment  
3 Backrest setting  
4 Thigh support setting  
5 Seat surface inclination setting  
6 Lumbar support setting

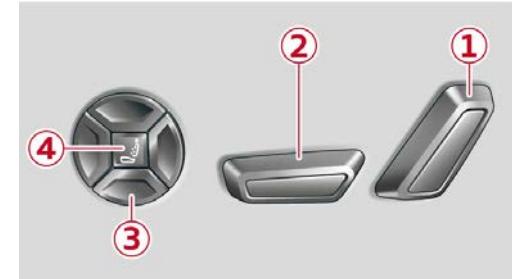



1 Backrest setting  
2 Longitudinal and height adjustment  
3 Lumbar support setting  
4 Massage function setting

### Electric convenience systems

Depending on the model series and vehicle equipment, Audi vehicles feature a range of electrically operated convenience systems, including:

- Electric doors
- Electric windows
- Electric sliding sunroof
- Electric seat adjustment
- Electric steering column adjustment
- Electric unlocking, opening and closing of the luggage compartment

If the battery or batteries are disconnected, these systems can no longer be operated.

|   |   |
|---|---|
|  | In the event of accidents involving triggering of the airbag, electrically operated doors and flaps are automatically unlocked. |
|  | Where possible, the electric convenience systems should be used for the rescue prior to disconnection of the battery.           |
|  | The battery should only be reconnected to the vehicle electrical system by workshop personnel.                                  |

# **5. Stored energy / liquids / gases / solids**



## Vehicle drive energy storage unit

Audi models are available with different drive concepts. Depending on the drive concept, fuel tanks (petrol and diesel), natural gas tanks or batteries may be installed in the vehicles as energy storage units or fuel storage units. This means that vehicles with a natural gas drive have a fuel tank in addition to several natural gas tanks.

Hybrid vehicles also have a fuel tank in addition to a battery (48 V or high-voltage). Fully electric vehicles only have a large high-voltage battery. An overview of the possible electrification variants for Audi vehicles is provided in section 1, "Identification/recognition".

Irrespective of the drive, each vehicle has one or more low-voltage batteries for the vehicle electrical system.



The installation positions of the fuel tanks, natural gas tanks and batteries are shown in the rescue card.

## Vehicles with a high-voltage system

“High-voltage” is used to describe the following voltage levels in automotive technology:

- More than 60 V with direct current (DC)
- More than 30 V with alternating current (AC)

### High-voltage components

In addition to the high-voltage battery, the electric machines, the external charging socket and the high-voltage distribution/control unit – also known as the power electronics – various auxiliary units, such as the high-voltage air conditioning compressor and auxiliary heater, are operated with high-voltage and interconnected via high-voltage power cables. All high-voltage power cables and high-voltage connectors are fitted with orange insulation in visible areas.

Multiple instances of the listed components may also be present in a vehicle. All other electrical components, such as lighting, vehicle electronics etc. are supplied with power by the 12-V electrical system.

Schematic diagram of a high-voltage system:

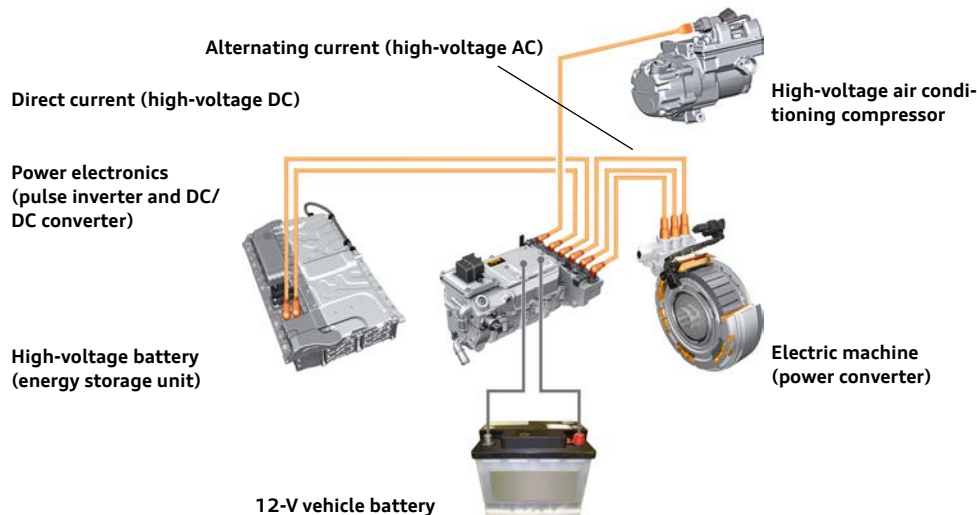

The installation positions of the high-voltage components and the path of the high-voltage power cables are shown in the rescue card.



**Audi Q4 e-tron**

SUV inkl. Sportback, ab 2021

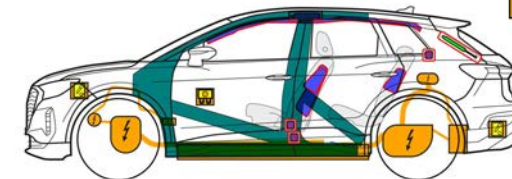
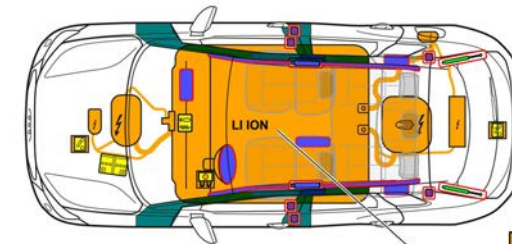

400 V  
LI ION

Hinweis: Es ist die maximal mögliche Ausstattung abgebildet.

|  |  |  |  |  |
|--|--|--|--|--|
|  |  |  |  |  |
|  |  |  |  |  |
|  |  |  |  |  |
|  |  |  |  |  |
|  |  |  |  |  |

Zusätzliche Informationen

Dokumentnummer  
rds\_au\_316\_001\_de

Version  
02/2021

Seite  
1 von 4

### High-voltage safety concept

The electric components in the vehicle, e.g. the power electronics, the electric machine, the high-voltage battery and auxiliary units such as an electric air conditioning compressor, work in voltage ranges above 60-V direct current (DC). These are connected with high-voltage power cables, which are marked with orange insulation as a warning that the hazard potential is greater than that of conventional vehicles.

All cables with an alternating current above 30 V are similarly identifiable by means of their orange marking. Should an insulation fault occur, e.g. as a result of external damage, this will be recognised by the system. The reaction can range from a simple indication that an insulation fault has occurred to a complete shutdown of the entire high-voltage system.

The high-voltage in the high-voltage system can pose a potential hazard in the event of improper handling. The vehicle therefore uses a comprehensive safety concept.

The following section explains the key principles of this safety concept.

#### Galvanic separation

The high-voltage system is galvanically isolated from the vehicle earth. This means that there is no direct electrical connection between the active components of the high-voltage system and the vehicle body.

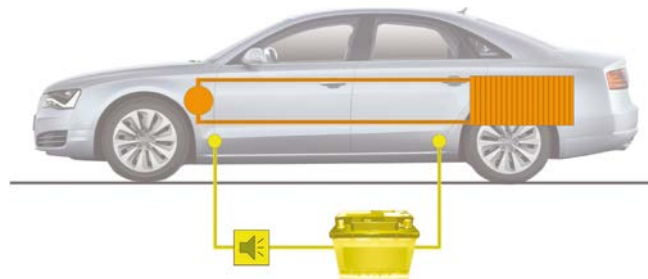

#### Accidental contact protection cover

The entire high-voltage system is insulated from the 12-V system and the body and is contact-safe by design.

#### Potential equalisation

The metal housings of all high-voltage components have an electrically conductive connection with the body. This ensures that no hazardous touch voltage can develop at the metal housing, even in the event of a fault.

#### High-voltage leads

All high-voltage power cables are fitted with orange insulation. Their orange sheathing serves as a clear visual signal. In some cases, the high-voltage cables are protected against damage by additional covers and tubing.

#### Short circuit detection

In the event of a short circuit or overcurrent, the overcurrent protection device (fuse) is triggered and interrupts the flow of current.

#### Discharge of residual voltages

In the event of an accident that triggers the seat belt pretensioner and/or airbags or in the event of an unexpected fault, the discharge circuit in the high-voltage system ensures that the high-voltage system is normally de-energised after approx. 20 seconds.

In all other cases, the high-voltage system can be disabled via actuation of an emergency high-voltage cut-out connection. Here too, the high-voltage system is de-energised approx. 20 seconds after the emergency cut-out connection is actuated.

#### Insulation monitoring

The insulation resistance of the high-voltage system is periodically checked for insulation monitoring purposes, i.e. to monitor whether the high-voltage system is insulated from the body.

Faults are indicated by a warning message to the driver, via illumination of a yellow or red lamp and emission of an acoustic signal from the instrument cluster.

## 5. Stored energy / liquids / gases / solids

### Switch off in case of crash

Each of the two battery terminals is fitted with a load contactor with a protective shutdown device that is closed when the high-voltage system is in operation. In the event of an accident that triggers the seat belt pretensioner and/or airbags, the high-voltage battery receives a crash signal to open the load contactors. The load contactors of the high-voltage battery open and the high-voltage system discharges outside the battery. The high-voltage connections of the high-voltage battery and all high-voltage components are then de-energised. On some vehicles, the shutdown after the crash signal is received is implemented by means of a pyrotechnic fuse, which ensures that the voltage of the high-voltage battery is interrupted.

Beyond the automatic crash shutdown, the vehicle-specific rescue cards for hybrid vehicles and electric vehicles contain information on how the high-voltage system and the vehicle can be disabled.



The high-voltage system is de-energised approx. 20 seconds after it has been shut off/disabled.

|  |  |
|--|--|
|  | Improper handling of high-voltage components and high-voltage power cables can prove fatal due to the high-voltage and the associated potential flow of current through the human body.  |
|  | Even after the high-voltage system has been disabled, there is still voltage in the high-voltage battery. The high-voltage battery must not be damaged or opened. There is a danger of death!  |
|  | When working with hydraulic rescue equipment, the position of the high-voltage components and high-voltage power cables must be taken into account when lifting, securing, towing or pulling the vehicle (see vehicle-specific rescue card). |
|  | Do not touch, cut or open damaged high-voltage components and/or high-voltage power cables. Wear suitable personal protective equipment! Cover damaged components with suitable equipment such as insulating blankets.                       |

## Warning labels for high-voltage components

All high-voltage components are labelled with clear warning stickers. The high-voltage power cables are an exception to this and are immediately recognisable by the orange warning colour of their sheathing.

Three types of warning sticker are always used:

- Yellow stickers with a warning symbol for electrical voltage
- Stickers with the word “Danger” on a red background

The yellow stickers refer to the high-voltage components that are installed near the sticker or concealed under covers.

The warning stickers with the “Danger” lettering indicate the high-voltage components directly.



Examples of warning stickers in high-voltage vehicles.



## The high-voltage battery

High-voltage batteries are rechargeable batteries. Various types of battery are used, depending on the manufacturer and the vehicle. They differ in the chemical components used in the battery cells for the anode, cathode and electrolyte, as well as in the shape of the cell (round, prismatic, pouch).



The high-voltage batteries used in Audi vehicles are lithium-ion batteries. The high-voltage battery is positioned in the vehicles inside a stable housing in areas that are protected against deformations in the majority of crash scenarios. The sizes and fitting locations of the high-voltage batteries differ depending on the type of vehicle. A fully electric vehicle requires a larger high-voltage battery than a hybrid vehicle.

On most electric vehicles, the high-voltage battery is screwed underneath the vehicle as a load-bearing body component. On hybrid vehicles, the high-voltage battery can usually be found in the rear vehicle compartment (in front of or behind the rear axle).

On both hybrid vehicles and electric vehicles, the high-voltage battery consists of battery cells connected in series that are combined into modules. Multiple modules are installed together with the peripherals in a metallic housing. The housing is connected to the vehicle via a potential equalisation cable.

All high-voltage batteries are installed in a stable housing to protect the battery cells in the event of an accident and to prevent electrolyte from escaping from defective battery cells.

|   |  |
|---|--|
|  | Depending on the vehicle variant/equipment, the high-voltage battery may consist of multiple battery packages. |
|---|--|

|   |  |
|---|--|
|  | In addition to the high-voltage battery, Audi electric vehicles also have at least one 12-V electrical system battery.   |
|  | Because there are so many different battery types with different chemical components and because battery technology is constantly developing, this guide cannot address the specific behaviour and hazards of each type. |

If the high-voltage battery is damaged or overheats, exothermic chemical reactions may occur (thermal runaway): These reactions result in the battery cells rapidly heating up. In this case, the battery will begin to burn and toxic vapours will be released.



Important information about this is provided in Section 6, “In case of fire”. Information on how to handle energy stored in the battery is also included in section 8, “Towing/transportation/storage”.

## 5. Stored energy / liquids / gases / solids



### Lithium-ion battery separated from the vehicle

If, in the event of an accident, the high-voltage energy storage unit and/or parts of it are separated from the vehicle, the high-voltage energy storage unit is presumed to pose an electrical, chemical, mechanical and thermal hazard.

The following points must be observed:

|  |   |
|--|---|
|   | In the event of damaged high-voltage energy storage units, high-voltage components or high-voltage cables, e.g. open components or torn cables, avoid touching these damaged areas as much as possible.   |
|   | When working with hydraulic rescue equipment, the position of the high-voltage components and high-voltage power cables must be taken into account when lifting, securing, towing or pulling the vehicle (see vehicle-specific rescue card).  |
|  | If work in these areas cannot be avoided, damaged parts or high-voltage energy storage units must be covered with electrically insulating material. In such cases, it is recommended to use a suitable electrically insulating pliable cover (undamaged plastic film or another suitable electrically insulating cover, e.g. in accordance with IEC 61112). |

If a high-voltage energy storage unit has been separated from a vehicle, other parts of the overall energy storage system may still be in or on the vehicle. Separated components of high-voltage energy storage units must only be lifted from the ground with electrically insulating equipment.

|   |  |
|---|--|
|  | Escaping electrolytes from damaged high-voltage energy storage units are irritant, flammable and potentially corrosive. Please wear appropriate personal protective equipment! |
|  | Work should only be carried out while wearing a folded-down helmet visor to ensure adequate face protection.   |

Any fluids escaping from high-voltage energy storage units are usually coolant. Electrolytes are only present in the individual cells in small quantities (millilitres).

## 5. Stored energy / liquids / gases / solids

The following illustrations show some examples of the different installation concepts for the high-voltage battery in Audi vehicles. The exact installation position of the high-voltage battery can be found in the rescue card for the respective model.

### Different installation concepts for the high-voltage battery

High-voltage battery in vehicle floor with additional package at rear (Audi e-tron)



Audi e-tron rescue card

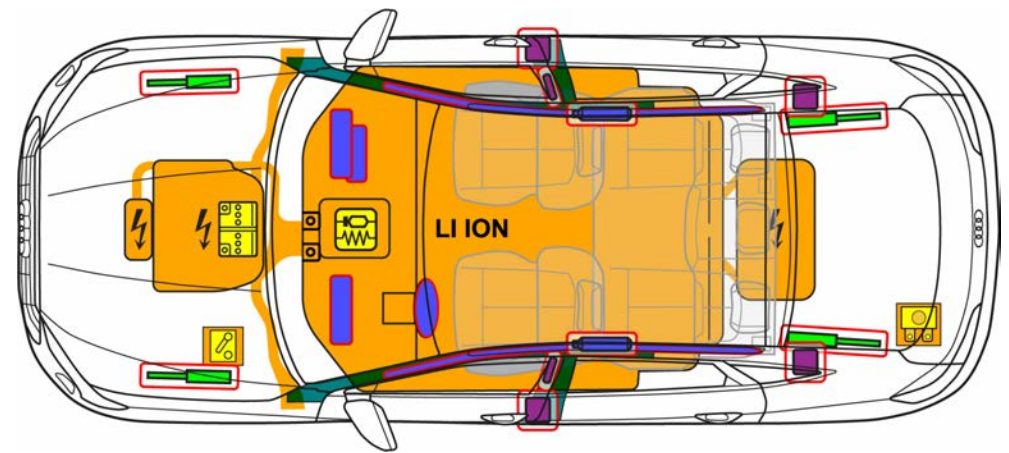



### Different installation concepts for the high-voltage battery

High-voltage battery in vehicle floor with "foot garage" for rear passenger compartment occupants (e-tron GT)

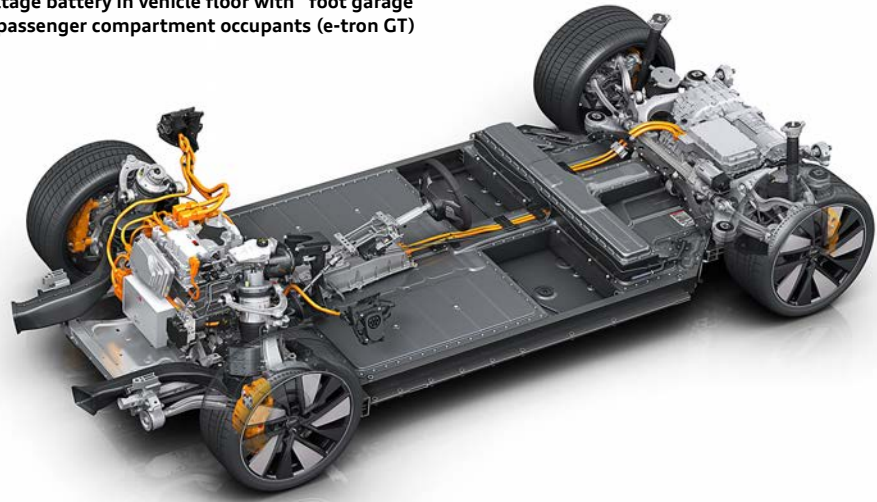

e-tron GT rescue card

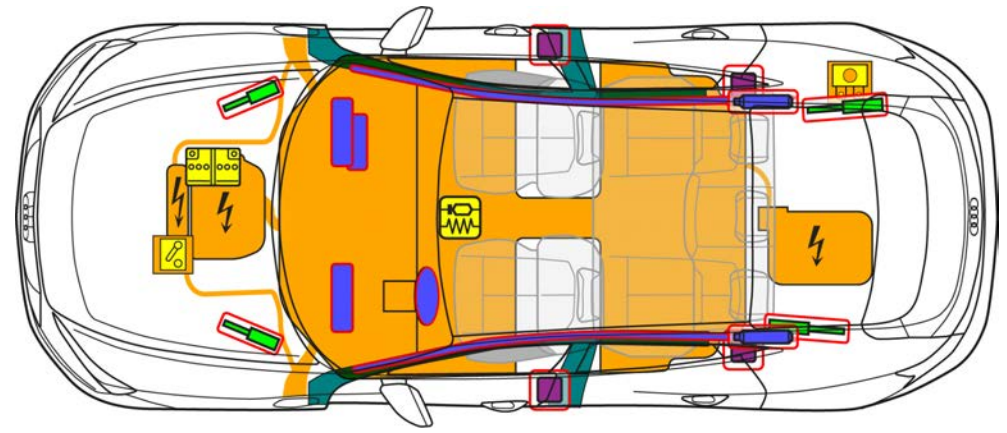

High-voltage battery in vehicle floor (Audi Q4 e-tron)

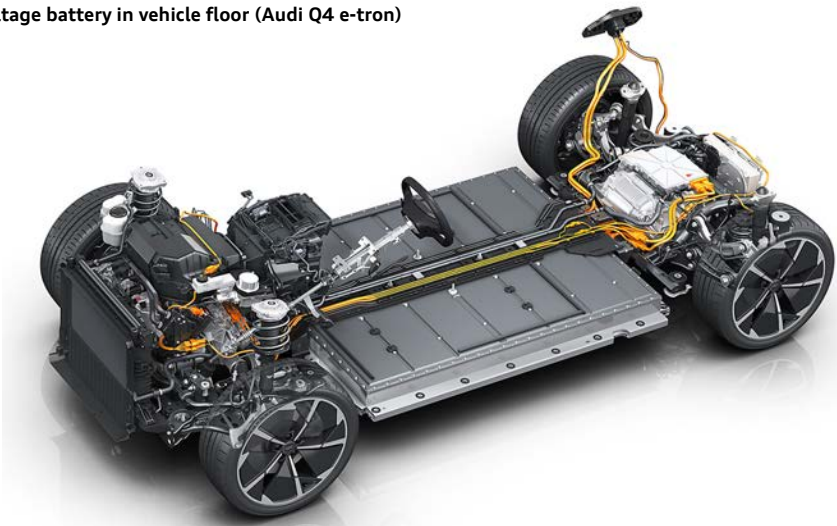

Audi Q4 e-tron rescue card

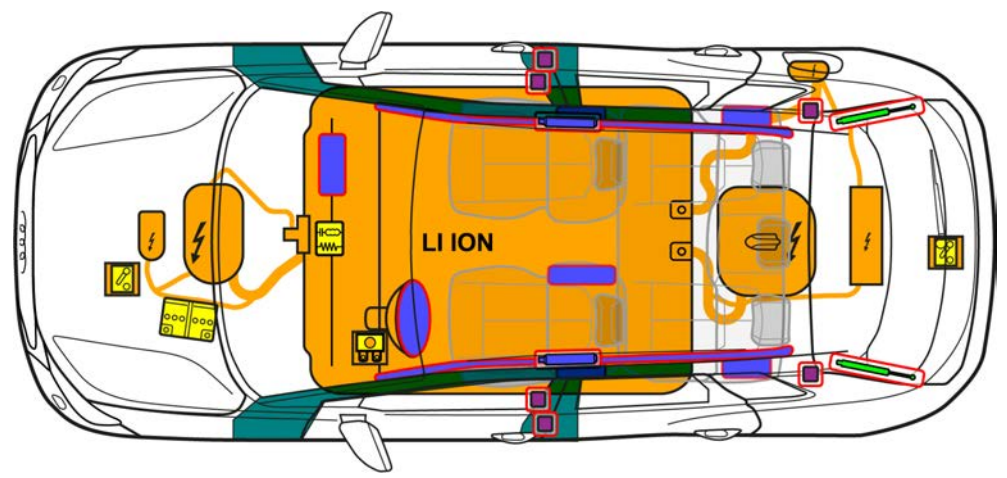

### Different installation concepts for the high-voltage battery

High-voltage battery in vehicle rear (Audi Q8 TFSI e)

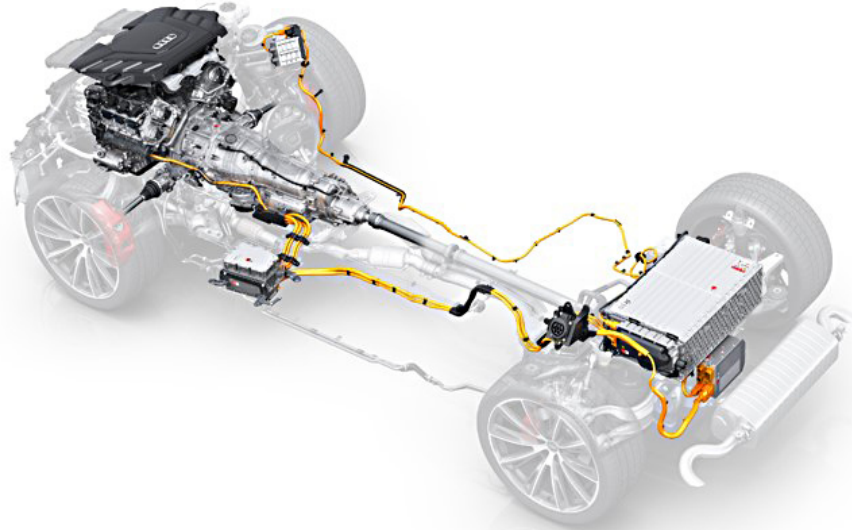

Audi Q8 TFSI e rescue card

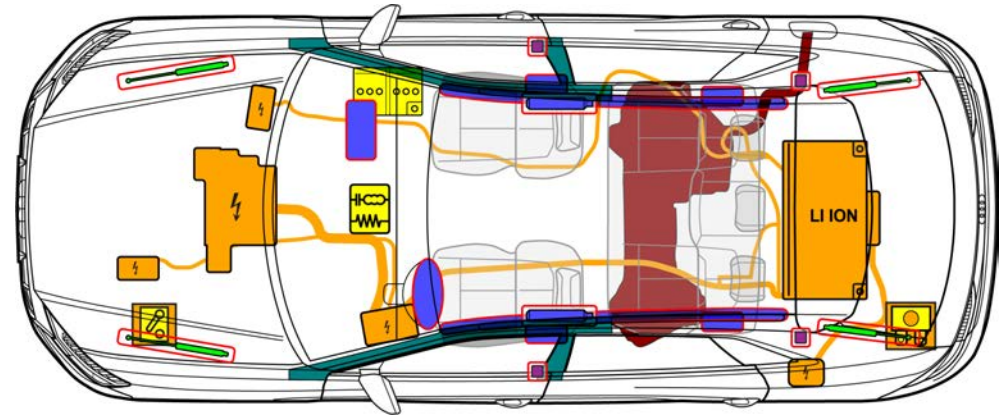

High-voltage battery in front of rear axle (Audi A3 TFSI e)

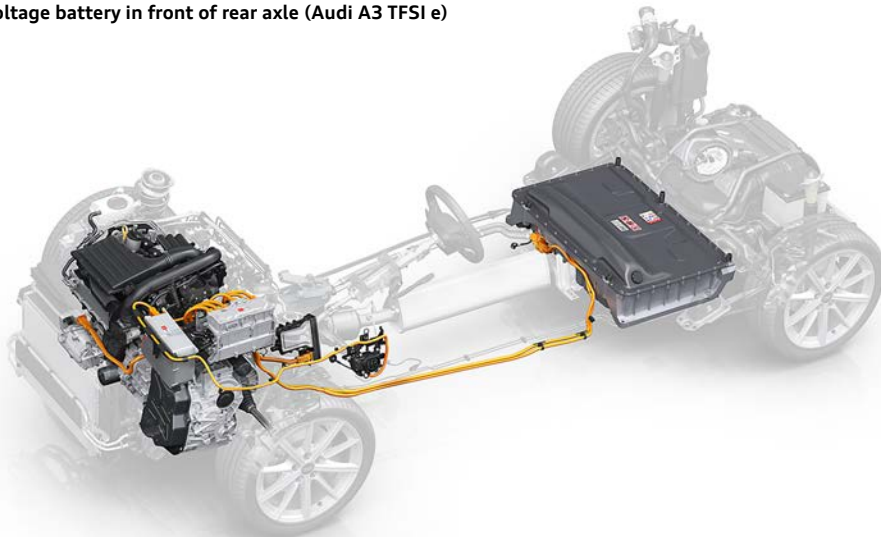

Audi A3 TFSI e rescue card

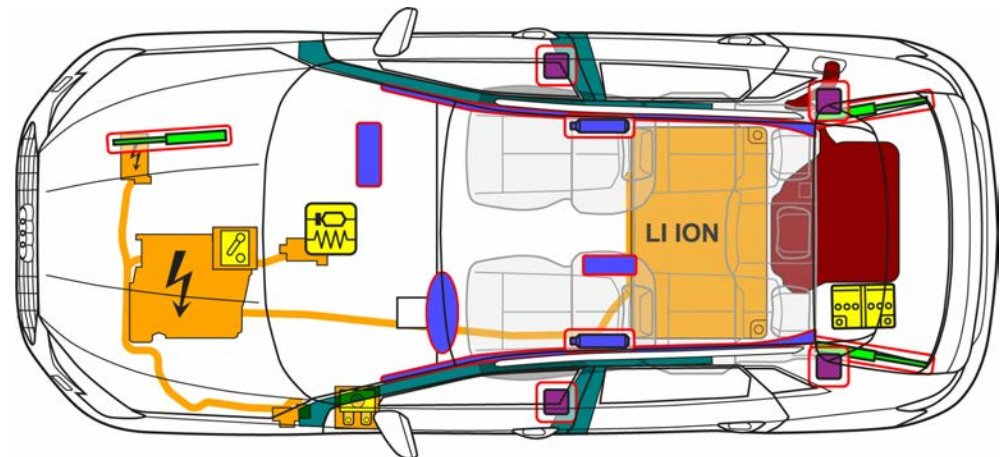

## Hazard warnings

### High-voltage battery



Audi models with high-voltage technology are fitted with lithium-ion batteries.

|              |   |
|--------------|---|
|              | <p>There is a risk of a thermal reaction in the high-voltage battery if coolant escapes from the battery cooling system.<br/>Lithium-ion batteries can self-ignite or reignite after a fire has been extinguished.<br/>Monitor the temperature of the high-voltage battery!</p> |
| <br><br><br> | <p>Avoid skin contact and inhaling electrolyte vapours, as electrolyte is flammable, corrosive and irritant.<br/>In the event of outgassing of the high-voltage battery, toxic vapours may form.<br/>Please wear appropriate personal protective equipment!</p>                 |
|              | <p>Contaminated extinguishing water must be dealt with according to the national procedures for emergency and recovery personnel.</p>   |

### 48-V battery 12-V battery







A lithium-ion battery is installed in Audi MHEV models with a voltage of 48 V. Some models may also have lithium-ion batteries with a voltage of 12 V.

|              |   |
|--------------|---|
|              | <p>Lithium-ion batteries can self-ignite or reignite after a fire has been extinguished.</p>  |
| <br><br><br> | <p>Avoid skin contact and inhaling electrolyte vapours, as electrolyte is flammable, corrosive and irritant.<br/>In the event of outgassing of the high-voltage battery, toxic vapours may form.<br/>Please wear appropriate personal protective equipment!</p> |
|              | <p>Vehicle-specific information is also described in the respective rescue cards.</p>   |

## 12-V vehicle electrical system battery

12-V batteries with lead-acid technology are primarily used as starter batteries in Audi models.

|  |  |
|--|--|
|   | <p>Escaping battery acid is highly flammable.</p>  |
| <br> | <p>There may be a highly explosive gas mixture in the battery. No flames, sparks, open light and smoking near the battery!<br/>Wear appropriate personal protective equipment!</p> <p>“Explosive” sticker on the battery</p> |
|   | <p>Escaping electrolyte can cause severe burns to skin.</p>  |
|   | <p>Vehicle-specific information is also described in the respective rescue cards.</p>  |

Further information is available from the battery section of the German Electro and Digital Industry Association (ZVEI): <https://www.zvei.org/en/association/sections/batteries-section>

## Flammable materials

Examples of these include:

- Plastics
- Electrolytes
- Resins
- Magnesium
- Gases or other flammable liquids

Resins are used for bonding carbon fibres, magnesium components are found in the engine compartment.

|   |   |
|---|---|
|  | <p>Avoid skin contact and inhaling electrolyte vapours, as electrolyte is combustible, corrosive and irritating. Please wear appropriate personal protective equipment!</p> |
|---|---|

## Natural gas vehicles

The natural gas tanks on the Audi g-tron models are installed on the underside of the vehicle at the rear. On the new Audi A3 g-tron, A4 g-tron and A5 g-tron models, an additional natural gas tank is fitted in the area of the rear axle and fuel tank. The A4 g-tron and A5 g-tron models also have a fourth natural gas tank, which is located in the rear above the auxiliary frame of the rear axle. The natural gas tanks are attached with tightening straps to a support that is screwed onto the body.

The natural gas tanks on the A4 g-tron and A4 Avant g-tron are made from a plastic material mix with a layered structure. On the A3 g-tron, the two natural gas tanks installed behind the rear axle are also made from a plastic material mix, while the natural gas tank in front of the rear axle is made of steel.

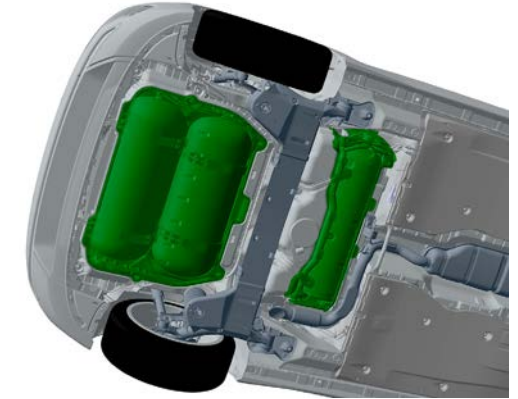

### Physical properties of natural gas

- Natural gas is a colourless, odourless, flammable gas
- Natural gas is mixed with an odourant, for example, for use in e.g. a vehicle. This allows any escape of natural gas to be detected before the lower explosion limit is reached
- Natural gas is lighter than air (the density ratio of natural gas to air is approx. 0.6) and therefore dissipates quickly outdoors
- Explosion range between 4% by volume and 17% by volume
- Ignition temperature approx. 640 °C

### Safety equipment

The entire natural gas system has been installed in a way that provides the best possible protection from damage and the effects of weather. The gas tanks are highly stable and heat resistant. The high-pressure pipes and connecting elements are made of seamless stainless steel and are routed outside the passenger compartment.

Along with the electromagnetic shut-off valves, the cylinder valves have an integrated thermal fuse and a flow rate limiter that prevents the uncontrolled escape of gas if any damage to the pipes occurs. A non-return valve is also installed in the refuelling line to the gas tanks. This prevents gas from flowing back out of the cylinder and into the filler line.

|   |   |
|---|---|
|  | <p>Contaminated extinguishing water must be dealt with according to the national procedures for emergency and recovery personnel.</p> |
|---|---|

|   |   |
|---|---|
|  | <p>Avoid skin contact and inhalation of broken carbon fibres.</p> |
|---|---|

### Different installation concepts for natural gas tanks

Audi A3 g-tron with three gas tanks



Audi A3 g-tron rescue card (in accordance with ISO 17840)

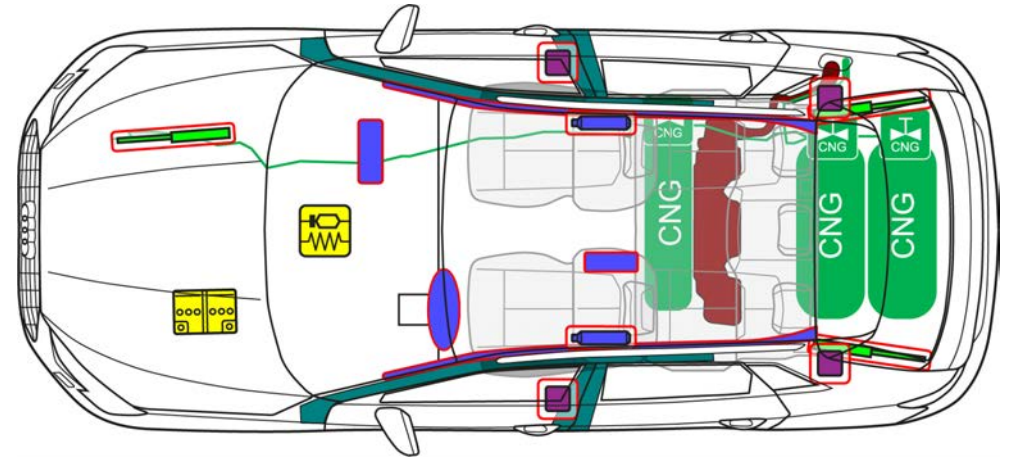

Audi A4 g-tron with four gas tanks

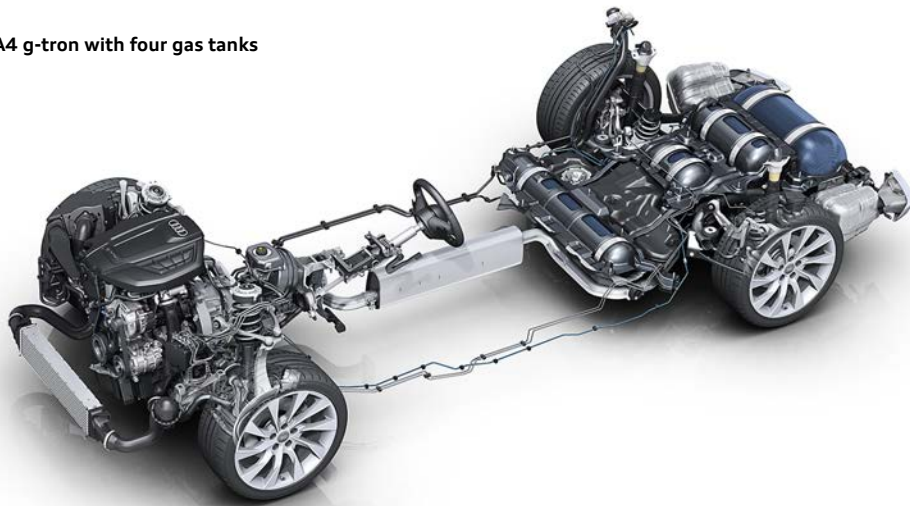

Audi A4 g-tron rescue card (does not correspond to the current ISO 17840)

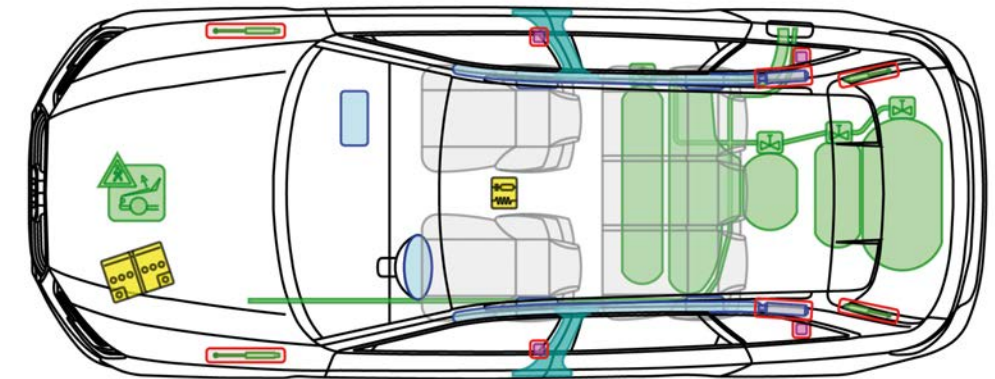

## Air conditioning system

The refrigerants R 134 a, R 1234 yf, R 744 and CO<sub>2</sub> are used for the air-conditioning systems. Further information on different coolants can be found on the following page:

<https://www.dguv.de/ifa/gestis/gestis/stoffdatenbank/index.jsp>

## Compressed air tanks

Some Audi models have accumulators for the air suspension or air conditioning systems, for example. Do not damage these accumulators and never open them by force.

## Flammable materials

Examples of these include:

- Plastics
- Electrolytes
- Resins
- Magnesium
- Gases or other flammable liquids

# 6. In case of fire



## Vehicle fire

In principle, all country-specific regulations, work instructions and guidelines issued by the respective fire-fighter associations and public authorities on how to proceed in the event of a vehicle fire must be observed. When possible, the fire must be prevented from spreading to the energy storage unit (fuel, gas, battery).

All the usual and familiar extinguishing agents such as water, foam, CO<sub>2</sub> or powder can be used.

Which extinguishing agent is to be used with which extinguishing method can only be decided at the deployment site, and is highly dependent on the actual situation and the equipment available.



If the airbags did not deploy during the accident, they may deploy in the event of a vehicle fire.



## Fire in high-voltage vehicles

Dealing with high-voltage vehicles is usually no more dangerous than dealing with petrol or diesel vehicles; however, a number of points may differ. Knowledge of these differences can be important for the rescue operations in the event of accidents involving passenger vehicles.

The following distinction must be made in the event of a vehicle fire with high-voltage vehicles:

- Vehicle fire in which the high-voltage battery does not catch fire:** As is the case for a passenger vehicle with a conventional drive, all standard and familiar extinguishing agents such as water, foam, CO<sub>2</sub> or powder can be used for a “normal” fire in a hybrid or electric vehicle (HEV or BEV, without the high-voltage battery catching fire) depending on requirements and/or availability.
- Vehicle fire in which the high-voltage battery catches fire:** Smoke, flying sparks and/or jets of flame from the battery may indicate that the lithium-ion battery is affected by the fire. When a high-voltage battery catches fire, it should be extinguished with water whenever possible and then be cooled. In this case, it must be ensured that sufficient water is used and, if possible, that the water enters the high-voltage battery through the openings caused by the fire or collision. The jet of water should be aimed as directly as possible at the battery. The installation position of the high-voltage battery can be found in the rescue card for the respective model.

The decision about which measures are suitable is made at the deployment site by the fire brigade, and is highly dependent on the actual situation (e.g. progress of the fire and time at which the fire brigade arrives) and the equipment available.

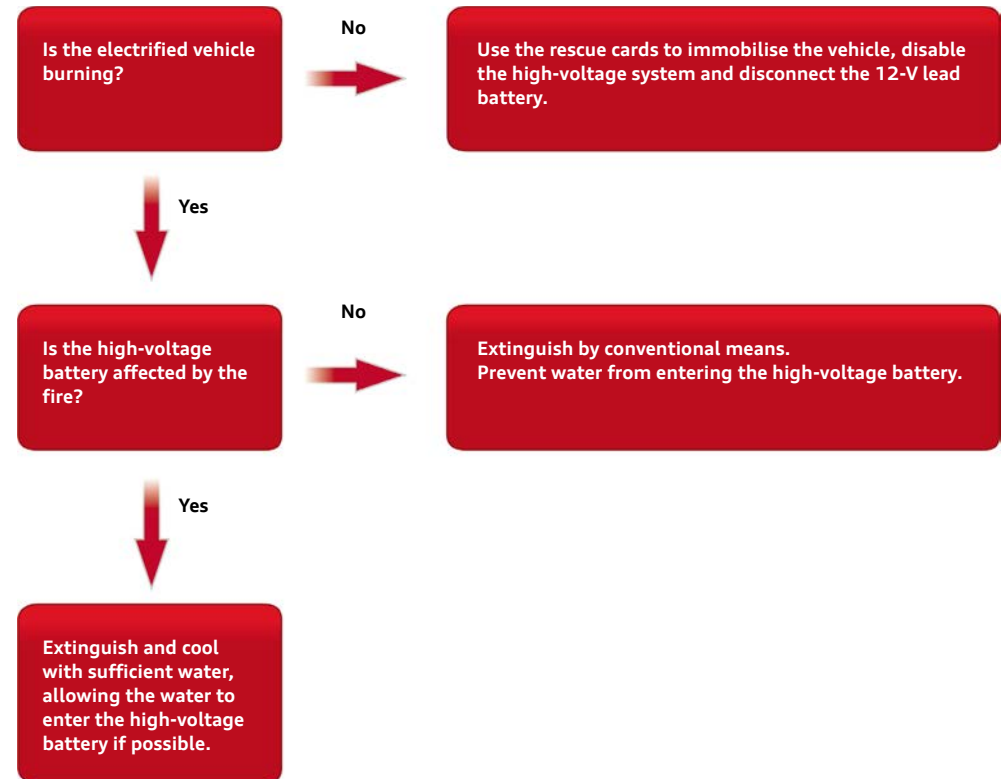

Flow chart for fires in electric vehicles.

If severe damage occurs (e.g. a dented, broken or cracked housing), a lithium-ion battery may react to the effect of water or effect of the fire immediately or only after a delay. This is why signs of a reaction (e.g. smoke, heat, noises, sparks etc.) must be observed during activities on a vehicle with a lithium-ion battery which has been in an accident.

In the event of a reaction by the lithium-ion battery, protective measures and countermeasures must be initiated. Harmful smoke is produced from fires in electric or hybrid vehicles, just as it is in vehicles with a conventional drive. This is why the corresponding personal protective equipment is recommended. In the event of a fire, outgassing of the high-voltage battery should be ex-



## 6. In case of fire





pected, as the battery features mechanical safety mechanisms that open, for example in the event of an increase in temperature or pressure due to a fire, and therefore result in deliberate “outgassing” and pressure release.

Extinguishing a vehicle with a high-voltage battery and extinguishing a burning high-voltage battery is possible. According to the VDA guide on rescue and recovery in accidents, water is the most suitable extinguishing agent and there is no fundamental difference from fighting a fire in a conventionally powered vehicle.

If the high-voltage battery is involved in a fire, large quantities of water are required to cool or extinguish an undamaged high-voltage battery that is reacting.

Following a reaction, the lithium-ion battery must be cooled with water until it has reached a temperature approximately equivalent to ambient temperature. The use of a thermal imaging camera or an infrared thermometer is recommended.

|   |   |
|---|---|
|   | After putting out the fire, there may still be hazardous voltages.  |
|  | When batteries are not completely burnt out, they may ignite again. Extinguished vehicles must be moved to a safe position, and it may be necessary to continue to observe and monitor the vehicle. |
|  | A sufficient safety distance must be maintained. Appropriate self-contained respiratory protection equipment must be worn.  |



|   |  |
|---|--|
|  | Evaporation and gases can be suppressed by spraying jets of water.   |
|  | Defective cells may burst, causing an exothermic reaction.   |
|  | A fire may break out some time after the accident, as there may be a residual risk of delayed fire. This is particularly the case if high-voltage energy storage units are damaged (see also section 8, “Towing/transportation/storage”). An electrical hazard may also persist. High-voltage components must not be touched and suitable personal protective equipment must be worn. High-voltage cables may have been damaged by the heat. |
|  | More information can be found on the respective rescue cards.  |



## Fires in gas vehicles

Dealing with natural gas vehicles usually is no more dangerous than dealing with petrol or diesel vehicles; however, there are also a number of special points in this case that must be observed during rescue operations for accidents involving passenger vehicles.

In the event of a vehicle fire in which the natural gas tanks are also exposed to heat, the thermal fuses will react at a temperature of approx. 110 °C and result in a defined discharge of the natural gas, which will ignite and burn off. It takes approx. 90 seconds for a full natural gas tank to discharge until it is completely empty.

Vehicles may be equipped with one or more gas tanks. The time at which a specific tank blows off/burns off cannot be determined precisely. As soon as no more natural gas is being blown off, conventional fire fighting can begin. If the natural gas tanks are not affected by the fire (e.g. in the event of a fire in the engine compartment), fire-fighting can also be initiated straight away.

|   |   |
|---|---|
|  | <p>When the overpressure protection reacts, gas escapes from the valve. If the vehicle is standing on its wheels, the flow of gas is directed downwards towards the ground. If the vehicle is lying on its side or on its roof, a darting flame may emerge to the side or upwards. Maintain a safe distance from the vehicle. Approach it from the front whenever possible.</p> |
|  | <p>Personal protective equipment must be worn, including self-contained breathing apparatus!</p>  |

|   |   |
|---|---|
|  | <p>If the airbags did not deploy during the accident, they may deploy in the event of a vehicle fire.</p>         |
|  | <p>A sufficient safety distance must be maintained. Corresponding personal protective equipment must be worn!</p> |
|  | <p>More information can be found on the respective rescue cards.</p>  |

# 7. In case of submersion

## Vehicle under water

A vehicle that is immersed in water must be dealt with in the same way as a damaged vehicle that has been in an accident. The safety and security regulations must be observed, and the procedure to eliminate immediate dangers must be followed, see section 3.

## High-voltage vehicle under water

- When it is in the water, the high-voltage system does not present an increased risk of electric shock.
- The same information applies as described in section 3, “Eliminating direct hazards/safety and security regulations”.
- The recovery procedure is the same as for conventional vehicles. This also applies to bodies made of carbon fibre reinforced polymers.

Source: German Association of the Automotive Industry (VDA), Accident Assistance and Recovery of Vehicles with High-Voltage Systems, FAQ.



In the event that water enters the high-voltage battery, electrolysis may be triggered and cause a deflagration of oxyhydrogen gas. The high-voltage system must be disabled (see section 3 “Disable direct hazards / safety regulations”). Wear appropriate personal protective equipment!

## Natural gas vehicle under water

- The same instructions as described in section 3 “Disable direct hazards / safety regulations” apply.
- The recovery procedure is the same as for conventional vehicles.

After recovering the vehicle, allow the water to drain.



If gas escapes, close the shut-off valves for the tanks (see section 3 “Disable direct hazards / safety regulations”).

# **8. Towing/ transportation/ storage**

### Recovering vehicles involved in accidents

When loading, transporting and storing, the instructions in the rescue cards must be observed.

### Recovering high-voltage vehicles involved in accidents from a danger area

Vehicles with high-voltage batteries should, in principle, be transported away on flatbed vehicles.

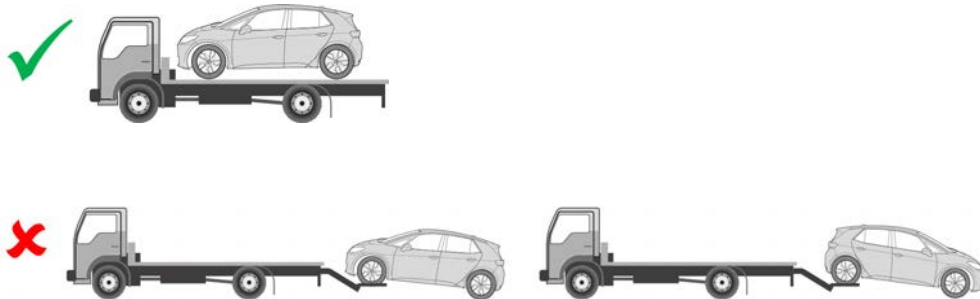

The high-voltage system must be disabled prior to transport, see section 3 “Disable direct hazards / safety regulations”.

Before the vehicle is transported away (e.g. by a towing company), the condition of the lithium-ion battery should be checked again. The vehicle may only be loaded and transported away if the vehicle does not show any signs of a reaction in the area of the lithium-ion battery for an extended period; see the flow chart on the next page.

If vehicles that have been in accidents have a damaged battery or the battery exhibits anomalies, wait until the reaction of the lithium-ion battery has abated before loading, so that no further reaction need be expected on the trans-



port route, see the flow chart on the next page. The shortest and safest route possible must be selected. Travelling through tunnels should be avoided. If necessary or if in doubt, the breakdown truck may need to be accompanied by a fire engine.

Vehicles with a damaged high-voltage battery should be transported to a safe storage location.

After they have been transported, electric or hybrid vehicles that have been in accidents should not be parked in enclosed buildings, but outdoors at a sufficient distance from other vehicles, buildings and combustible objects or surfaces.







If possible, designated “quarantine areas” at the storage location should be used. The vehicle involved in the accident must be parked in a suitable location outdoors, since it is still theoretically possible that the lithium-ion battery may react. The parking space must be marked accordingly (signs/fencing). A minimum distance of five metres must be maintained to other vehicles, buildings or flammable objects. The distance can be reduced by taking appropriate measures, e.g. fire barriers etc.

The persons responsible at the towing company, the workshops and, if relevant, the scrapyard must be made aware of the special features of and risks presented by the vehicle.

|   |  |
|---|--|
|  | Lithium-ion batteries can self-ignite or re-ignite after fire-fighting measures!   |
|  | In the event that vehicles that have been in accidents have a damaged battery or the battery exhibits anomalies: disable the high-voltage system (see section 3). Park the vehicle at a safe distance of at least 5 m from buildings and other vehicles (quarantine area). |



## 8. Towing/transportation/storage

|   |  |
|---|--|
|    | When loading the vehicle, take care not to damage the high-voltage components. If possible, lift the vehicle at the indicated lifting points.  |
|    | Vibrations during transport may cause high-voltage batteries to self-ignite again.   |
|    | Recommendations for specific vehicles can be found on their rescue cards.  |
|    | Whenever possible, monitor any changes in temperature using corresponding devices, e.g. IR camera, for an extended period.   |
|    | A large metal container is recommended for transporting away a high-voltage energy storage unit or parts thereof that have been disconnected from the vehicle. The condition of the high-voltage energy storage unit must be observed (e.g. development of smoke, noises, sparks, development of heat) and flooding of the metal container must be prepared. |
|  | Further information about this can be found in section 5 “Stored energy / liquids / gases / solids” (lithium-ion battery that has been disconnected from the vehicle).   |

Before the vehicle is transported away, the condition of the lithium-ion battery should be checked.

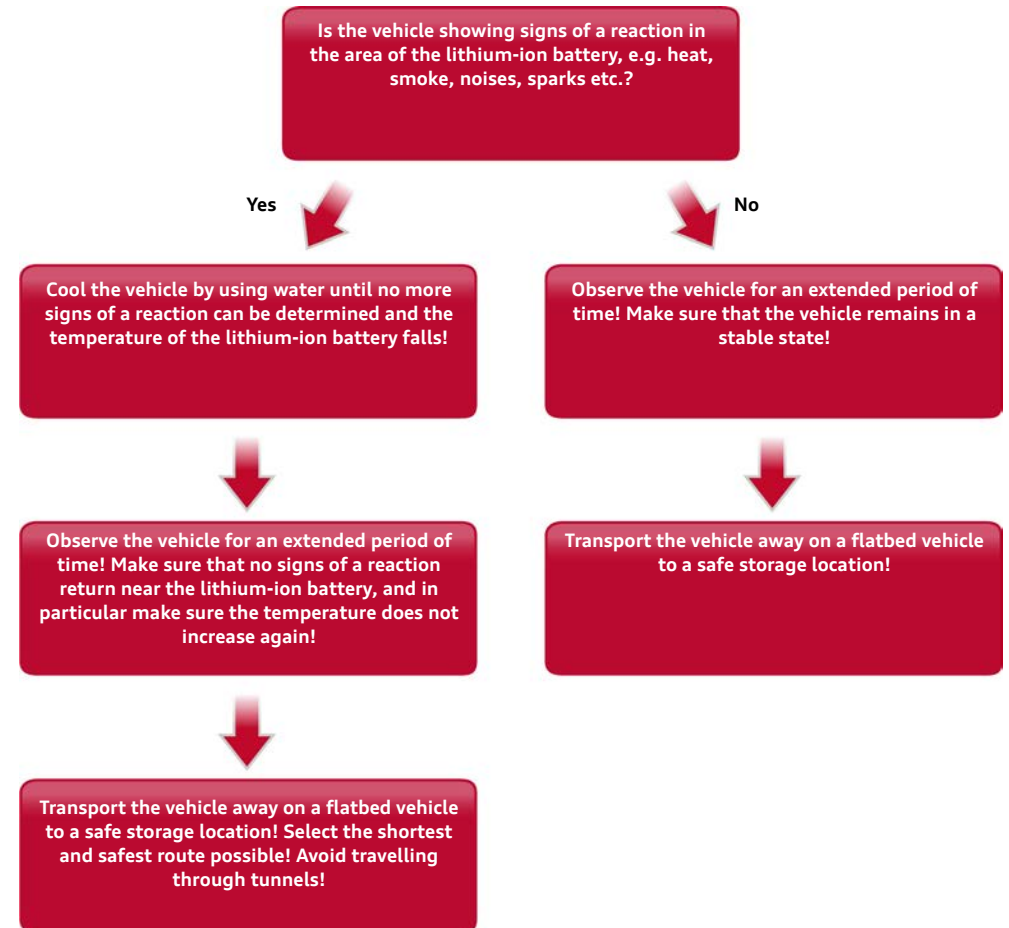





Flow chart for towing electric vehicles.

## Recovering natural gas vehicles involved in accidents from a danger area

When loading, transporting and storing, the instructions in the rescue cards must be observed.

Prior to transportation, shut off the natural gas tanks manually; see section 3, “Disable direct hazards / safety regulations”.

|   |   |
|---|---|
|    | A vehicle that has been in an accident must not be towed away by the drive axles.   |
|    | When towing and parking the vehicle, make sure that the gas tanks are not damaged.  |
|    | If gas escapes, shut off the shut-off valves for the tanks manually (see section 3, “Disable direct hazards / safety regulations”). |
|  | Recommendations for specific vehicles can be found on their rescue cards.   |

# 9. Important additional information

Modern vehicles have extensive occupant protection systems which can vary according to the vehicle type and specification package.

### Airbag

A current vehicle with maximum equipment includes the following main components:

- Airbags
- Airbag control unit
- Sensors
- Seat belt pretensioners
- Components that release the rollover bar in convertibles

Pre-tensioned springs or pyrotechnics are used to trigger it. The job of the electronics integrated in the airbag control unit is to detect vehicle deceleration and acceleration and decide whether to deploy protection systems.

In addition to the sensors in the airbag control unit, other sensors (e.g. crash sensors in the front doors) are also used to detect vehicle deceleration and acceleration during an accident. Only once they have evaluated the information from all sensors do the electronics in the airbag control unit decide whether and when to activate the safety components. Depending on the nature and severity of the accident, they may, for example, deploy the seat belt pretensioners only or the seat belt pretensioners together with the airbags.

The control unit is indicated as follows on the rescue cards:

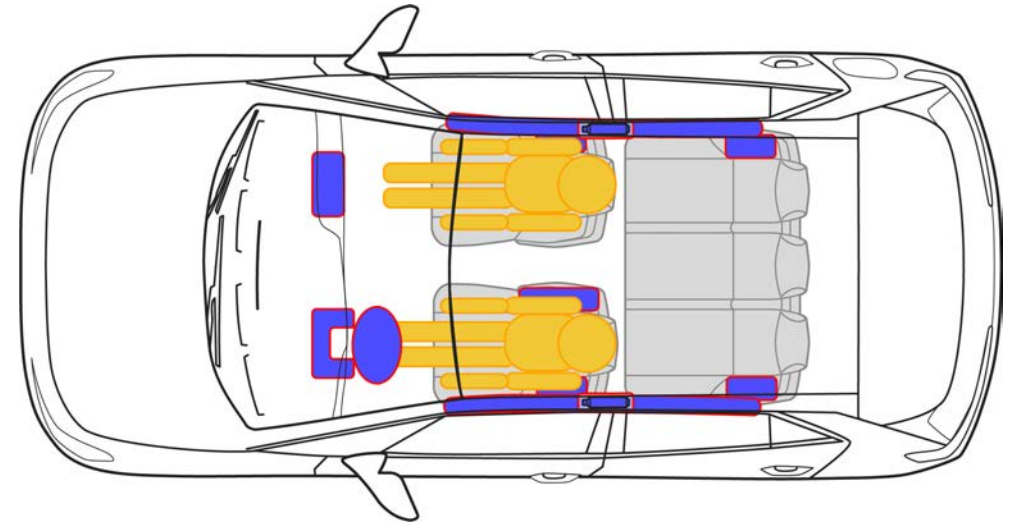

Airbags in today's vehicle models.

Only those safety systems which afford protection in the specific accident situation are triggered.

Besides the main function of controlling the airbags, the airbag control unit can also have the following additional functions:

- Emergency release of the central locking
- Switching on the interior lights
- Switching off the fuel pump
- Switching on the hazard warning lights
- Transmission of a signal to send the eCall

Stored gas inflators produce the quantity of gas required for inflating the airbags, filling the airbags within milliseconds. The inflated airbags protect vehicle occupants who are wearing seatbelts from striking the inner body contours (e.g. the steering wheel, dash panel etc.) in the event of a severe accident. Depending on the installation location and requirements, stored gas inflators of various designs or modes of action are used.

## 9. Important additional information

The safety systems are triggered depending on the type of accident or direction of impact

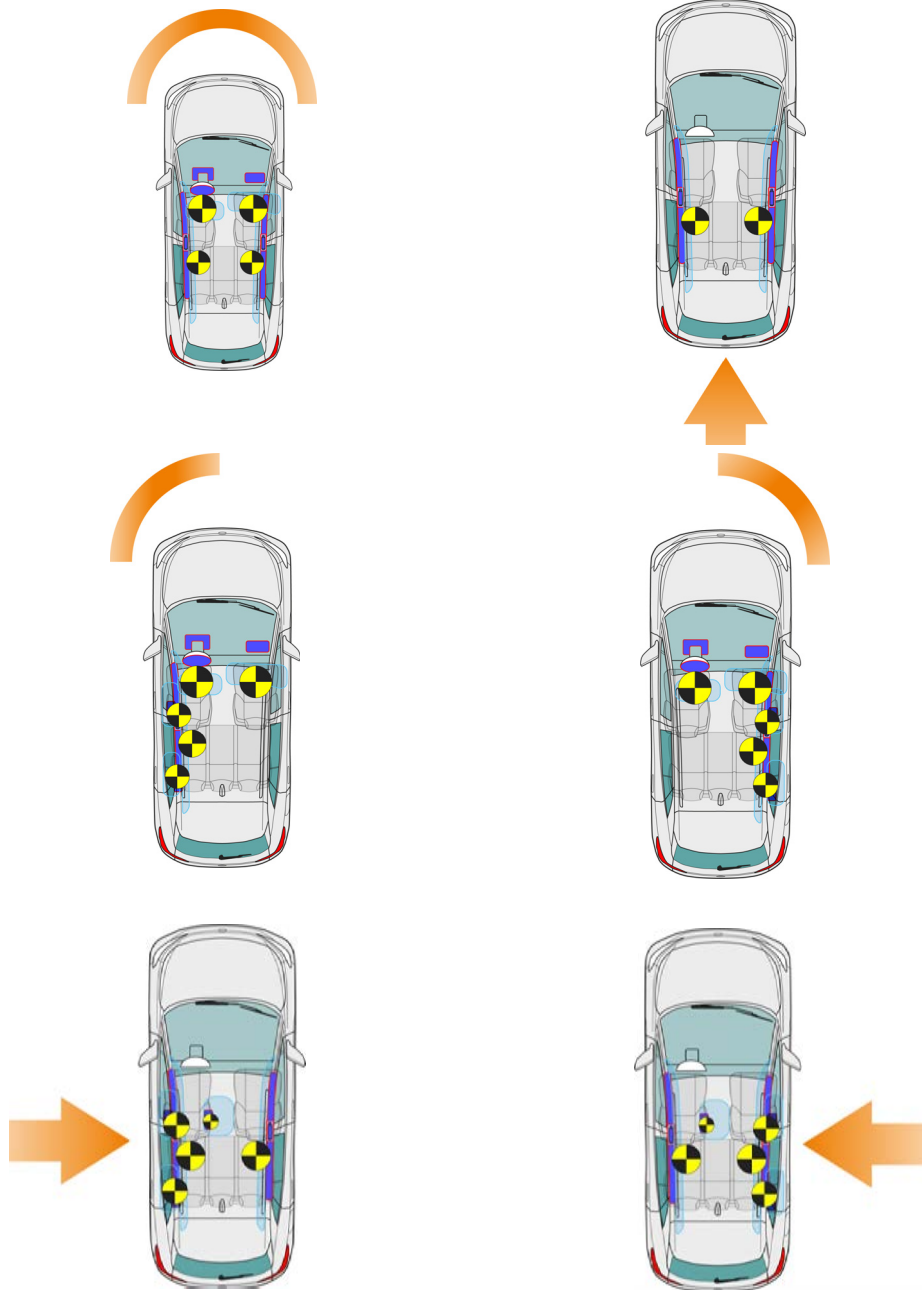

The safety systems are triggered depending on the type of accident or the direction of impact (ms = milliseconds).

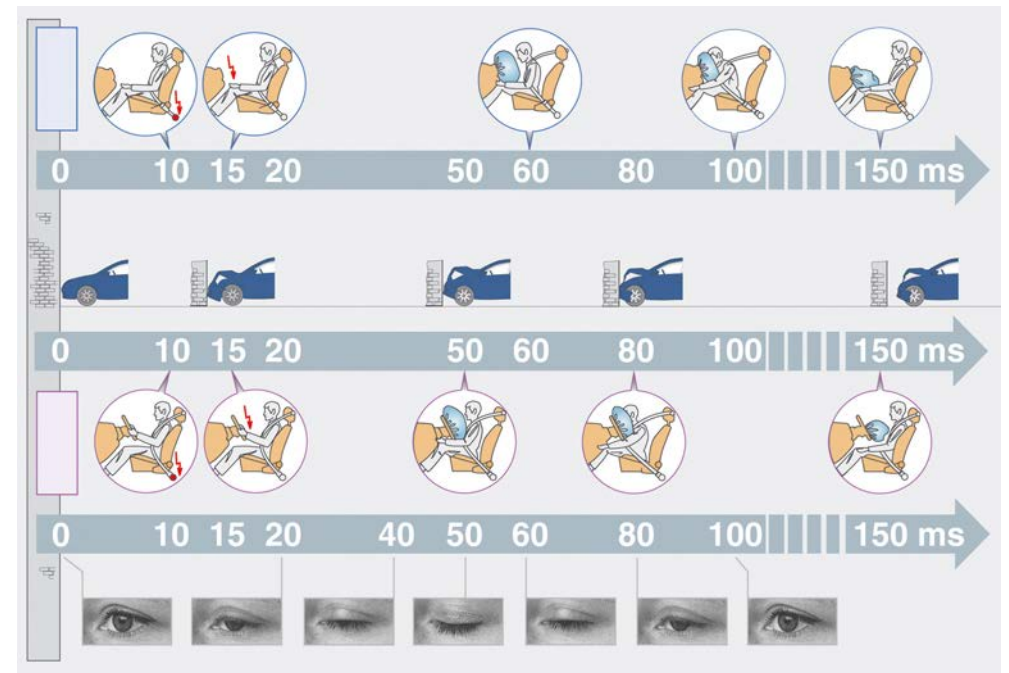

Airbags are indicated in the rescue cards as symbols or outlines as follows:

|  |   |
|--|---|
|  | <p>Driver airbag, front passenger airbag, side or centre airbag, knee airbag and curtain airbag</p> |
|--|---|

## 9. Important additional information

### Front airbags

#### Driver airbag

The driver airbag unit essentially consists of a cap, the airbag and a stored gas inflator. It is fitted in the steering wheel and electrically connected to the airbag control unit via a contact unit.

The airbag is folded up under the cap and its shape and size are designed so that it inflates as protection between the driver and steering wheel.

The driver airbag is inflated by a stored gas inflator. The unfolding airbag breaks the cap on the steering wheel along a special seam and is instantly filled with gas. The entire process from ignition of the stored gas inflator to the fully inflated airbag only takes a few milliseconds.

Vents on the side facing away from the driver reduce the kinetic energy of the upper body impact by allowing the gas to escape at a controlled rate.

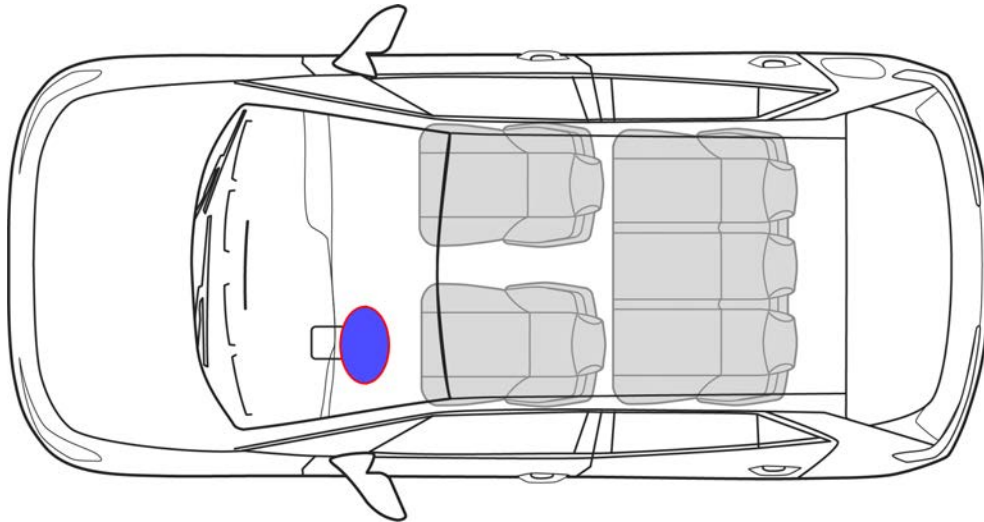

#### Front passenger airbag

The airbag unit for the front passenger is located in the dash panel in front of the passenger seat. Because the airbag unit is further from the occupant, the front passenger airbag has a much larger volume. The action, function and process sequence of the front passenger airbag are comparable to those of the driver airbag.

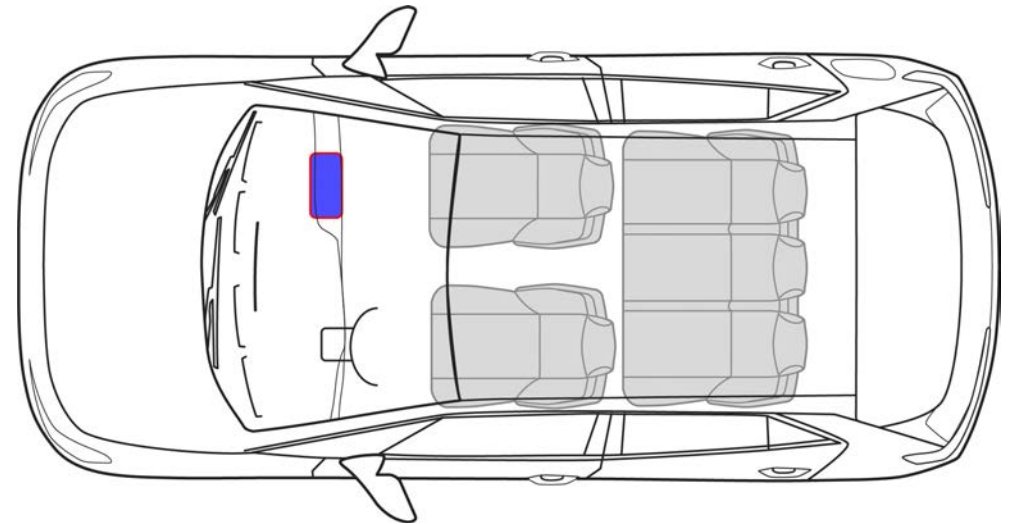

## 9. Important additional information

### Knee airbag

The design of the knee airbag is similar to that of the front passenger airbag. It is located in the footwell trim below the dash panel.

The knee airbag is always deployed together with the driver airbag. Single-stage stored gas inflators are used to inflate the knee airbags. The deployment of the knee airbag reduces the occupants' risk of knee and leg injury, and connects the occupant sooner to the vehicle's deceleration.

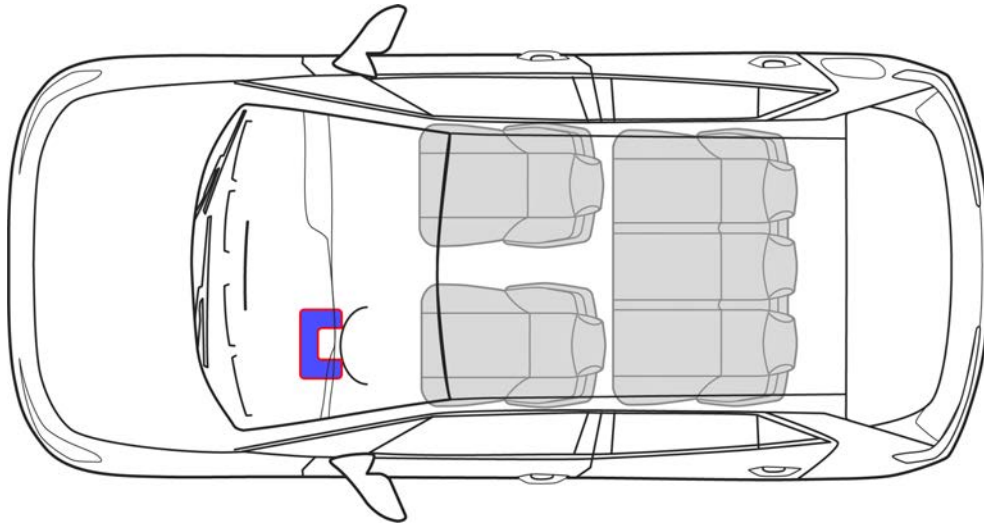

### Side airbag

In a lateral collision, side airbags protect the occupant's thorax and pelvis on that side of the vehicle and reduce the impact on the occupant. They inflate at the side between the occupant's upper body and any trims that protrude, and therefore distribute the force of the impact on the occupant more evenly, who is thereby paired with the motion of the intrusion early on.

The side airbags are installed in the backrest of the driver and front passenger seats, and on the outer seats in the second row of seats in a number of Audi

models. This guarantees a uniform distance to the vehicle occupants in every seat position.

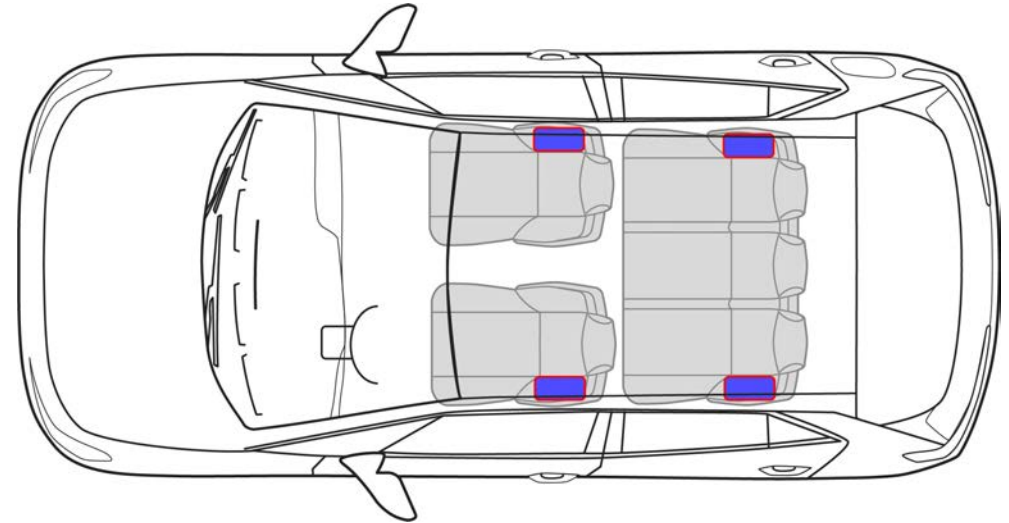

### Head-thorax airbags

The head/thorax airbags for the driver and front passenger are integrated in the front seat backrests. The design and function are similar to those of a side airbag.

It extends from the occupant's ribcage to the head and is particularly used in convertibles where a curtain airbag is not possible.

## 9. Important additional information

### Centre airbag

Centre airbags are installed in the driver seat armrest on the tunnel side. They prevent a collision between the heads of the driver and the front passenger, and prevent the driver from being thrown too far to the passenger side if it is unoccupied.

On the four-seat variant of the Audi A8 L, an additional centre airbag is installed at the rear in the rear shelf.

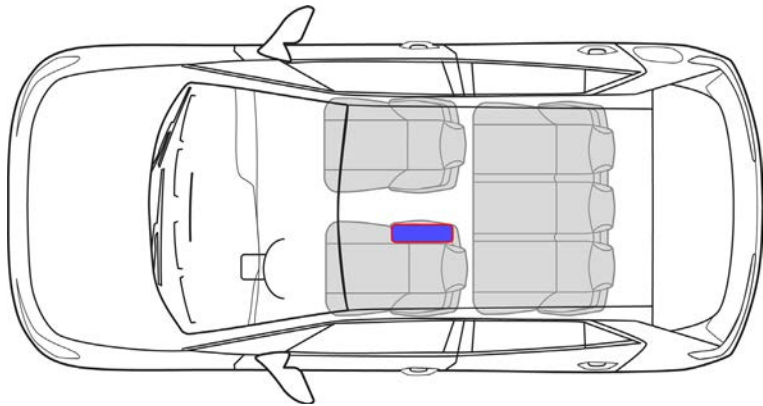

Tunnel-side front centre airbag

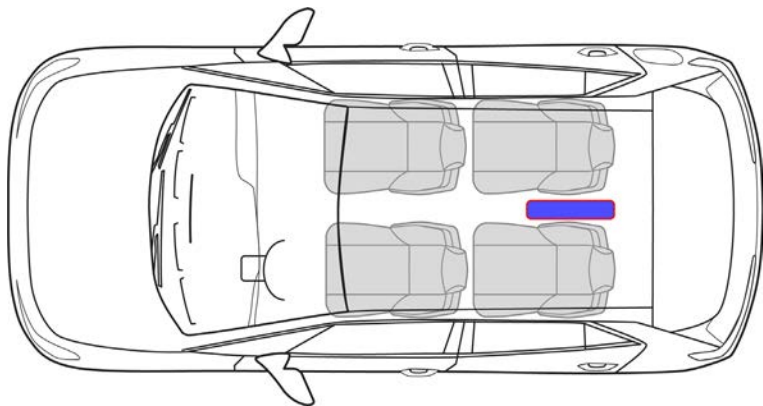

Rear centre airbag on the Audi A8 L four-seater

### Curtain airbags

Curtain airbags serve to protect the head in the event of a side impact. They consist of a large airbag in the roof lining, usually extending from the A-pillar to the C-pillar.

Depending on the vehicle model, the stored gas inflators may be installed in the roof near the B-pillar, between the B- and C-pillars, between the C- and D-pillars or even in the rear roof area. The exact installation position is outlined in the rescue cards.

In contrast to front and side airbags, the curtain airbag can retain its internal pressure for some time after being deployed. This is to provide protection if the vehicle subsequently overturns or secondary collisions occur.

Both the side and curtain airbags are deployed by the airbag control unit when a limit configured in it is reached. A side impact is detected by lateral acceleration sensors or pressure sensors in the doors.

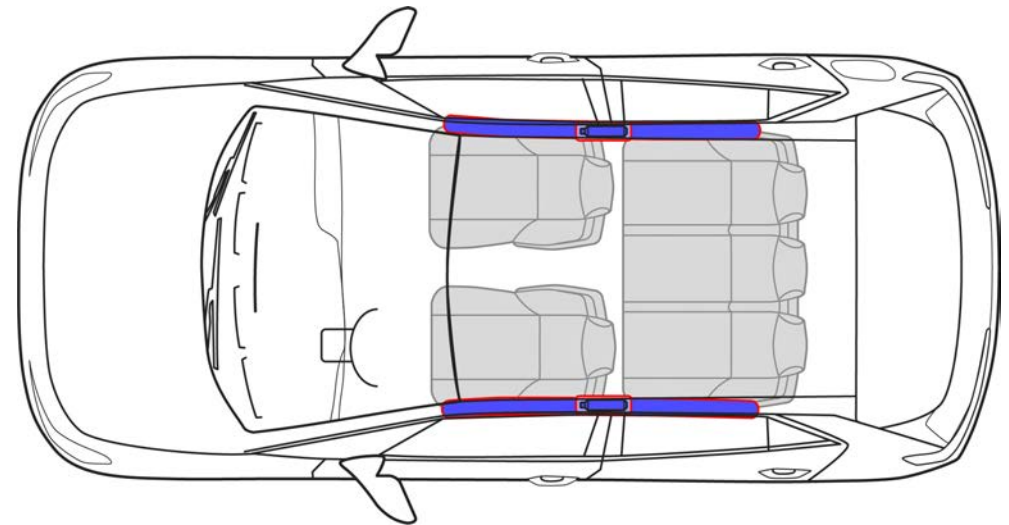



## Airbag stored gas inflators

### Solid propellant inflators

The solid propellant inflators consist of a housing containing a solid propellant charge with an ignition unit. When the solid propellant is ignited, the airbag is filled with non-toxic gas.

**Procedure:**

- The igniter is activated by the airbag control unit.
- The propellant charge is ignited and quickly combusts.
- The gas thus produced flows through the metal filter into the airbag.

### Hybrid stored gas inflators





The hybrid stored gas inflators consist of a housing containing a highly compressed gas, combined with a solid propellant charge and an ignition unit. The design and shape of the inflator housing are adapted to the installation conditions. These inflators are usually tubular. The main components are the pressure vessel for the airbag inflation gas, and the (solid) propellant charge which is integrated in the pressure vessel or flange-mounted on it. The solid propellant is used in tablet or ring form. The stored and compressed gas is a mixture of inert gases, for example argon and helium. Depending on the stored gas inflator design, it is pressurised to between 200 bar and 800 bar.

- When the solid propellant is ignited, it opens the pressure vessel, producing a gas mixture consisting of the solid propellant and the inert gas mixture. The igniter is activated by the airbag control unit and the propellant charge is ignited.

|   |  |
|---|--|
|  | <p>Do not damage the stored gas inflators during rescue work. The compressed gas in the pressure vessel and the pyrotechnic propellants may pose a hazard to the emergency services and the occupants.</p> |
|---|--|

## Seat belt pretensioners

In the event of a crash, seat belt pretensioners retract the belt in the opposite direction to which it is being pulled – this reduces slack (a gap between the belt and the body). This acts as soon as possible to prevent the occupant from being thrown forward (relative to the motion of the vehicle). A seat belt pretensioner can retract the seat belt by up to 200 mm within 10 ms. The seat belt pretensioners are integrated in the belt system. However, they may be installed in different locations depending on the type of vehicle (for example in the B-pillar, in the side member beside the seat or on the outside of the rear seat) and have different functional principles. In some cases, two seat belt pretensioners may even be used on one seat.

|   |   |
|---|---|
|    | <p>This means seat belt pretensioners should not be damaged with rescue equipment if at all possible. Avoid hammering on this area.</p>                     |
|    | <p>The belt also locks if the vehicle is at a steep angle, has overturned or, possibly, if the seat belt pretensioner has been damaged by the accident.</p> |
|  | <p>Non-triggered seat belt pretensioners with mechanical activation can still be triggered even after the battery is disconnected.</p>                      |
|  | <p>If the situation allows, the seat belt should be taken off or cut off as soon as possible.</p>   |
|  | <p>Label for seat belt pretensioners</p>  |

Installation variants

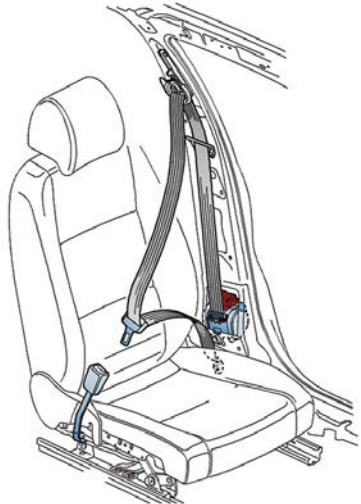
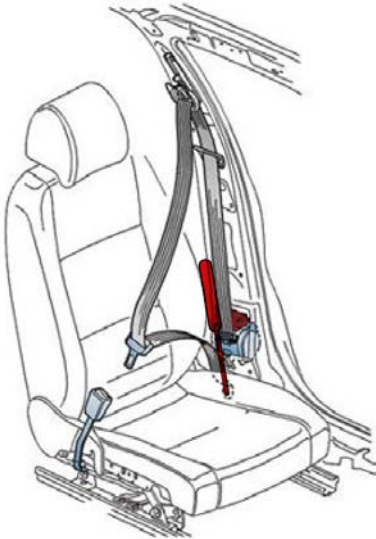
| Variant  | Fitting location   |
|--|--|
|   | <p><b>Driver/front passenger variant 1</b><br/>                     In the front compact pretensioner, the three-point automatic seat belt and seat belt pretensioner with electric or mechanical ignition trigger form a single unit and are installed in the B-pillar.</p> <p><b>Driver/front passenger installation variant 1 – compact pretensioner in the B-pillar</b></p>  |
|  | <p><b>Driver/front passenger variant 2</b><br/>                     Compact pretensioner (automatic belt with seat belt pretensioner) and lap belt pretensioner are both installed in the B-pillar (both pretensioners with electric ignition trigger).<br/>                     The lap belt pretensioner is installed above the compact pretensioner.</p> <p><b>Driver/front passenger installation variant 2 – compact pretensioner and lap belt pretensioner in the B-pillar</b></p> |

Installation variants

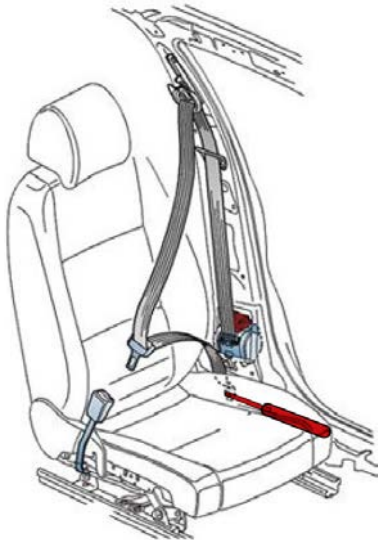
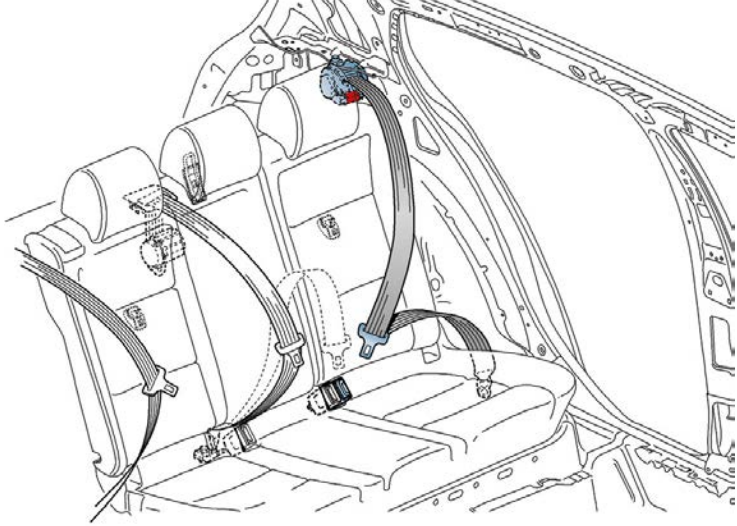
| Variant   | Fitting location  |
|---|---|
|   | <p><b>Driver/front passenger variant 3</b><br/>           Compact pretensioner (automatic belt with seat belt pretensioner) and lap belt pretensioner are installed independently of one another (both pretensioners with electric ignition trigger).<br/>           The lap belt pretensioner with electric ignition trigger is installed at the side member/B-pillar.</p> <p><b>Driver/front passenger installation variant 3 – compact pretensioner in the B-pillar, lap belt pretensioner in the area of the side member/B-pillar</b></p> |
|  | <p><b>Rear seat variant 1</b><br/>           In the rear compact pretensioner, the automatic belt and seat belt pretensioner with electric or mechanical ignition trigger form a single unit and are installed behind the rear seat backrest.</p> <p><b>Rear seat installation variant 1 – compact pretensioner at the rear in the area of the C/D-pillar (on vehicles with a pretensioner for the middle rear seat, the compact pretensioner is located in the backrest)</b></p>   |

Installation variants

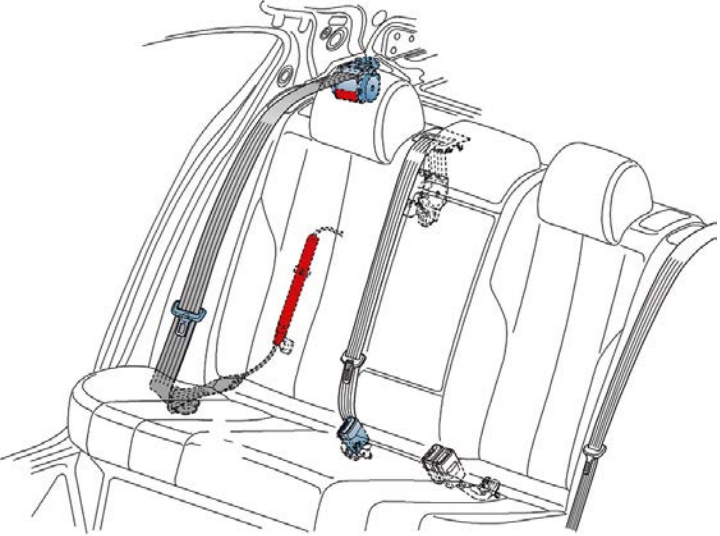
| Variant   | Fitting location   |
|---|--|
|  | <p><b>Rear seat variant 2</b><br/>                     The compact pretensioner at the rear (automatic belt with seat belt pretensioner) and the lap belt pretensioner are arranged independently of one another. The compact pretensioner with electric ignition trigger is installed in the area of the C/D-pillar. The lap belt pretensioner with electric ignition trigger is installed in the area of the C-pillar wheel housing bracket.</p> <p><b>Installation variant 3 – compact pretensioner and lap belt pretensioner in the area of the C/D-pillar or C-pillar wheel housing bracket</b></p> |

## Roll bar



Convertibles must provide the greatest possible protection for occupants even when the roof is open. This is why a rollover protection system is used, which in combination with reinforced A-pillars provides a protective zone for the occupants. It can be rigid or dynamic.

A dynamic system functions as follows:

- The airbag control unit contains a sensor for detecting if the vehicle is about to roll over.

Together with other sensors in the control unit, the severity of the accident is determined and the rollover bar and seat belt pretensioners are deployed. The rollover bar is also deployed as a precaution in the event of a severe frontal, lateral or rear impact as soon as a seat belt pretensioner or airbag is triggered.

It is deployed via a rollover bar trigger unit. A pre-tensioned spring moves the bar to the protective position within 0.25 seconds, and it is locked in the extended position by a latching mechanism.

|   |   |
|---|---|
|  | <p>If the rear window is still intact when the rollover bar is triggered, the rollover bar may not break through it. If the window is removed as part of the rescue operation, the rollover bar is pushed up a further 10 cm. It could hit emergency and recovery personnel and scatter glass shards.</p> |
|  | <p>Rollover bar label</p>   |

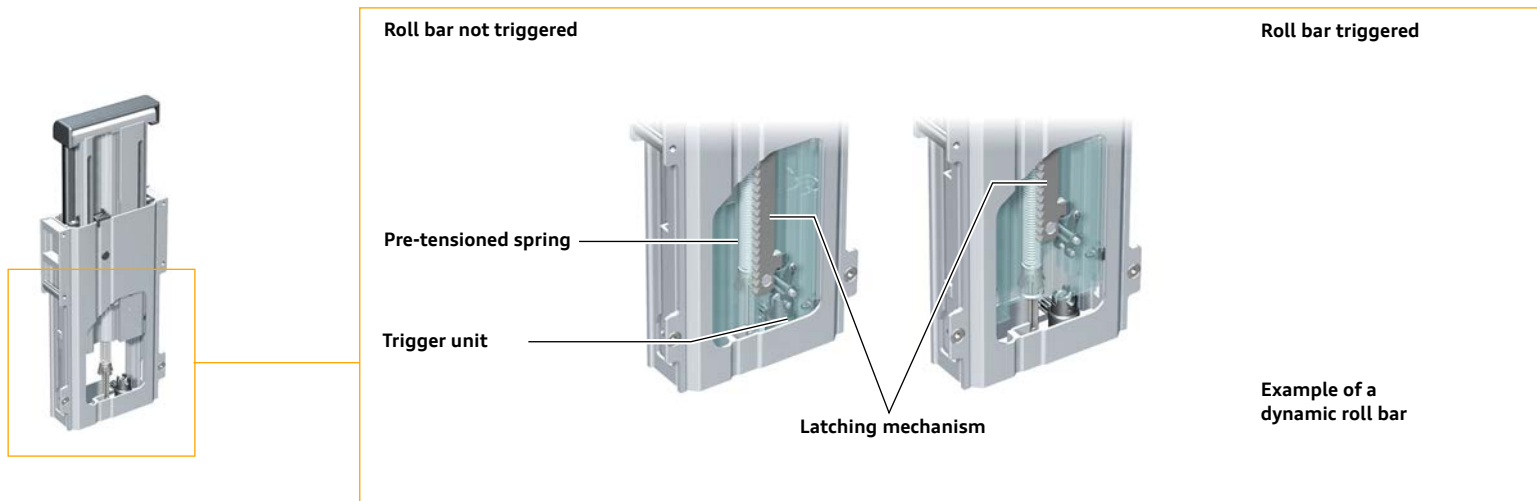

### Re-active bonnet

To ensure optimum protection for pedestrians, some Audi vehicle models are equipped with an active bonnet.

In the event of a collision with a pedestrian, the front and rear of the active bonnet are raised by pre-tensioned gas struts and pyrotechnic propellants. This increases the space between the bonnet and engine. The bonnet can absorb more impact energy in this position, thereby reducing the severity of injury caused by the engine.

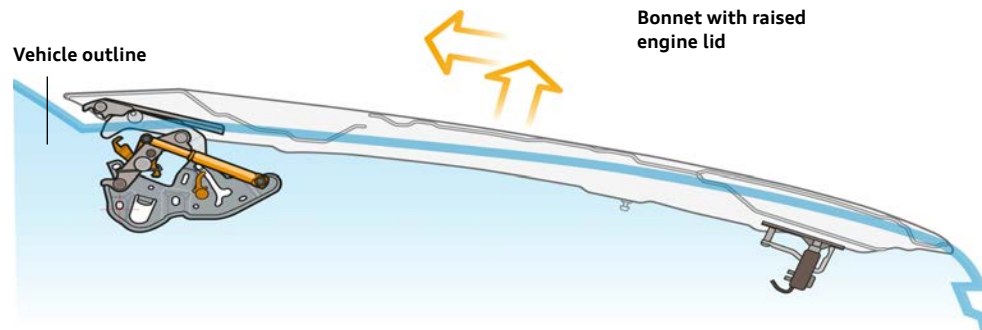

### Sources, further information

- German Association of the Automotive Industry (VDA): Accident assistance and recovery of vehicles with 48-V and high-voltage systems
- DGUV: Hinweise für die Brandbekämpfung von Lithium-Ionen-Akkus bei Fahrzeugbränden (Information for fighting fires in lithium-ion batteries in vehicle fires) (FBFHB 024)



Do not damage the stored gas inflators during rescue work. The compressed gas in the pressure vessel and the pyrotechnic propellants may pose a hazard to the emergency services and the occupants.



Label for active bonnet in rescue card

# 10. Explanation of pictograms used

## 10. Explanation of pictograms used

Components, functions and measures that have to be taken into account during a rescue operation are indicated by specific pictograms

The standardised pictograms have the following purposes:

- To indicate on the rescue cards where the respective components/functions are located in the vehicle (for details, see ISO 17840-1 and ISO 17840-2)
- To indicate a specific function or danger; these may be used in the sections of the additional pages of the rescue card or of the guide for emergency personnel
- To show how to identify the type of drive
- To indicate fire-fighting measures

Importance:

- 1 = Information that is essential for the rescue depending on the vehicle type/model
- 2 = Optional information which provides additional support for rescue measures



A number of pictograms may be adapted to reflect the actual size and shape.  
A combination of simple forms can also be used.

### Pictograms concerning recognition



Examples for identifying the drive type

Reference: ISO 17840-4

Importance: 1

Used for:

- Rescue card illustration
- Guide for emergency personnel, section 1

Note: Example pictograms for petrol and electric drive systems are shown here.

See ISO 17840-4 for principles and other drive pictograms.



10. Explanation of pictograms used

**Pictograms concerning access to the components**



**Title/meaning/reference:**  
**Bonnet**

**Function/description:**  
 Identifies the control that opens the compartment outside the interior at the front of the vehicle. The pictogram may have a frame to distinguish it from the background.

**Importance:** 2

**Used for:**

- Rescue card illustration
- Guide for emergency personnel, section 3

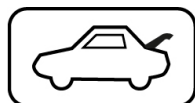

**Luggage compartment/boot**

Identifies the control that opens the compartment outside the interior on the rear of the vehicle. The pictogram may have a frame to distinguish it from the background.

**Importance:** 2

**Used for:**

- Rescue card illustration
- Additional pages of the rescue card, section 3
- Guide for emergency personnel, section 3

**Pictograms concerning disabling of the vehicle (excluding high voltage)**



**Apparatus for switching off the power sources in the vehicle**

All power sources in the vehicle are switched off using:

- Ignition key
- Button
- Measure in the engine compartment
- Measure on the dash panel
- Battery switch
- Other measure

**Importance:** 1

**Used for:**

- Rescue card illustration
- Additional pages of the rescue card, section 3
- Guide for emergency personnel, section 3

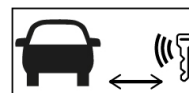

**Removing the Keyless Access key**

Reminder to remove the Keyless Access key from the vehicle so that the engine is not accidentally started. Optionally, a safety distance may be specified.

**Importance:** 1

**Used for:**

- Rescue card illustration
- Additional pages of the rescue card, section 3
- Guide for emergency personnel, section 3

## 10. Explanation of pictograms used

### Pictograms concerning disabling of the vehicle (excluding high voltage)

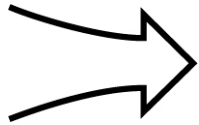

#### Air intake

Identifies the air intake that can admit CO<sub>2</sub> to stop the engine.

Importance: 1

Used for:

- Rescue card illustration
- Additional pages of the rescue card, section 3
- Guide for emergency personnel, section 3

### Pictograms concerning disabling of the vehicle high voltage (EV, HEV, PHEV, FCEV)

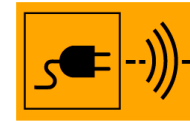

#### Vehicle with inductive charging system

Indicates that the vehicle is connected to an electromagnetic induction source for charging the high-voltage batteries. Shows the location of the induction charging system and its components.

Importance: 1

Used for:

- Rescue card illustration
- Additional pages of the rescue card, section 3
- Guide for emergency personnel, section 3

### Pictograms concerning disabling of the vehicle high voltage (EV, HEV, PHEV, FCEV)

- Orange = high-voltage system (class B voltage)
- Yellow = control of the high-voltage system by the low-voltage system
- Orange coloured frame = procedure for disabling the high-voltage vehicle



#### Hazardous voltage

Indicates hazards caused by dangerous voltages.

Importance: 1

Used for:

- Rescue card illustration
- Additional pages of the rescue card, relevant section as necessary
- Guide for emergency personnel, relevant section as necessary

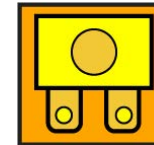

#### Fuse socket for disabling the high-voltage system

Identifies the low-voltage fuse that controls the high-voltage system.

Importance: 1

Used for:

- Illustration and additional pages of the rescue card, section 3
- Guide for emergency personnel, section 3

## 10. Explanation of pictograms used

### Pictograms concerning disabling of the vehicle high voltage (EV, HEV, PHEV, FCEV)



#### Cut cable

Identifies which cable to cut in order to disconnect the high-voltage and SRS components from the power network. Indicates that the cable must be cut at two separate points.

The size and proportions may be adapted to the intended purpose.

Importance: 1

Used for:

- Illustration and additional pages of the rescue card, section 3
- Guide for emergency personnel, section 3



#### Devices for disconnecting the high-voltage system (e.g. maintenance connector)

Identifies the device that disconnects the high-voltage system, as well as the personal protective equipment (PPE) that may have to be used.

Importance: 1

Used for:

- Rescue card illustration
- Illustration and additional pages of the rescue card, section 3
- Guide for emergency personnel, section 3

### Pictograms concerning disabling of the vehicle high voltage (EV, HEV, PHEV, FCEV)



#### Devices for disconnecting the high-voltage system

Identifies the low-voltage device that disconnects the high-voltage system.

Importance: 1

Used for:

- Rescue card illustration
- Illustration and additional pages of the rescue card, section 3
- Guide for emergency personnel, section 3

### Pictograms concerning access to the occupants

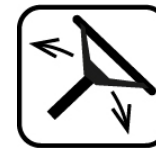

#### Steering wheel inclination adjustment

Identifies the control for adjusting the steering wheel inclination up or down. The pictogram may have a frame to distinguish it from the background.

Importance: 2

Used for:

- Guide for emergency personnel, section 4



#### Seat height adjustment

Identifies the control for adjusting the seat height up or down. The pictogram may have a frame to distinguish it from the background.

Importance: 2

Used for:

- Guide for emergency personnel, section 4

## 10. Explanation of pictograms used

### Pictograms concerning access to the occupants



#### Seat longitudinal adjustment

Identifies the control for moving the seat forward or back. The pictogram may have a frame to distinguish it from the background.

Importance: 2

Used for:

- Guide for emergency personnel, section 4



#### Lifting point, central support

Identifies the points on the vehicle that the manufacturer deems suitable for placing a jack or support.

Importance: 1

Used for:

- Rescue card illustration
- Illustration and additional pages of the rescue card, section 2
- Guide for emergency personnel, section 2

### Other vehicle-related pictograms

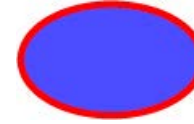

#### Airbag

Identifies an airbag.

Airbag versions, e.g.:

- Driver/front passenger airbags
- Side airbag
- Curtain airbag
- Knee airbag
- Belt airbag
- Centre airbag

Importance: 1

Used for:

- Rescue card illustration
- Guide for emergency personnel, section 9



#### Airbag stored gas inflator

Identifies an airbag stored gas inflator.

The pictogram shows the location of a stored gas inflator, e.g. for curtain airbags or active pedestrian protection systems.

This pictogram is not used for conventional airbag systems with integrated stored gas inflators, such as the front airbag in the steering wheel or dash panel, side airbags and knee airbag.

Importance: 1

Used for:

- Rescue card illustration
- Guide for emergency personnel, section 9

10. Explanation of pictograms used

Other vehicle-related pictograms



**Seat belt pretensioners**

Identifies a seat belt pretensioner.

If a seat has more than one seat belt pretensioner (e.g. for hip and shoulder belts), all seat belt pretensioner positions should be indicated with a pictogram.

Importance: 1

Used for:

- Rescue card illustration
- Guide for emergency personnel, section 9



**Gas strut, pre-tensioned spring**

Identifies a gas strut.

The red border is only used when the device is triggered.

The pictogram can be modified to reflect the actual size and shape.

Importance: 1

Used for:

- Rescue card illustration
- Guide for emergency personnel, section 9

Other vehicle-related pictograms



**Active pedestrian protection system**

Identifies the active pedestrian protection system.

The pictogram for active pedestrian protection systems is intended to indicate that the vehicle is equipped with a system that can be triggered (e.g. the bonnet). The background of the pictogram is usually white, but the colour of the trigger mechanism may be used as an alternative.

The pictogram can be combined with the trigger mechanism of the system (e.g. bonnet) or connected to it (airbag, stored gas inflator, gas strut, pre-tensioned spring).

Importance: 1

Used for:

- Rescue card illustration
- Guide for emergency personnel, section 9



**High-strength area**

Identifies a high-strength area.

Importance: 1

Used for:

- Rescue card illustration
- Guide for emergency personnel, section 9

## 10. Explanation of pictograms used

### Other vehicle-related pictograms

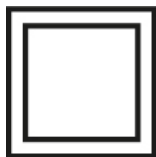

#### Special attention

Identifies the area to which particular attention should be paid.

Importance: 1

Used for:

- Illustration and additional pages of the rescue card, section 5
- Guide for emergency personnel, section 5



#### Carbon structure

Information that the vehicle body contains carbon. Indicates that there is a risk of inhalation and that appropriate PPE must be used.

Importance: 1

Used for:

- Illustration and additional pages of the rescue card, section 5
- Guide for emergency personnel, section 5

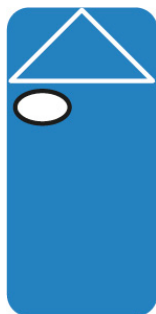

#### Left-hand drive

Identifies a left-hand drive vehicle.

For use in the header of the rescue card. The colour may be changed to stand out from the background of the header.

Importance: 1

Used for:

- Rescue card illustration

### Other vehicle-related pictograms



#### Right-hand drive

Identifies a right-hand drive vehicle.

For use in the header of the rescue card. The colour may be changed to stand out from the background of the header.

Importance: 1

Used for:

- Rescue card illustration

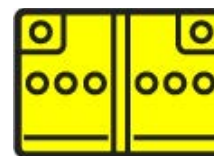

#### Low-voltage battery

Identifies a low-voltage battery.

The battery technology should also be indicated (e.g. Li-Ion or NiMH) if it is a conventional battery.

Importance: 1

Used for:

- Rescue card illustration
- Illustration and additional pages of the rescue card, section 5
- Guide for emergency personnel, section 5

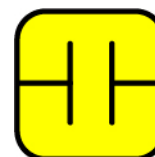

#### Low-voltage supercapacitor

Identifies a low-voltage supercapacitor.

Importance: 1

Used for:

- Rescue card illustration
- Illustration and additional pages of the rescue card, section 5
- Guide for emergency personnel, section 5

## 10. Explanation of pictograms used

### Other vehicle-related pictograms



#### Solar cell

Identifies a solar cell.

Importance: 1

Used for:

- Rescue card illustration
- Illustration and additional pages of the rescue card
- Guide for emergency personnel, section 3



#### SRS control unit

Identifies an SRS control unit.

Importance: 1

Used for:

- Rescue card illustration
- Guide for emergency personnel, section 9



#### High-voltage battery

Identifies a high-voltage battery.

The battery technology should also be indicated (e.g. Li-Ion or NiMH). Optionally, the nominal voltage of the battery can be indicated.

Importance: 1

Used for:

- Rescue card illustration
- Additional pages of the rescue card, section 3
- Guide for emergency personnel, section 3

### Other vehicle-related pictograms



#### High-voltage supercapacitor

Identifies a high-voltage supercapacitor.

Importance: 1

Used for:

- Rescue card illustration
- Illustration and additional pages of the rescue card, section 5
- Guide for emergency personnel, section 5



#### High-voltage component

Identifies a high-voltage component.

The lightning bolt may be omitted if there is not enough space.

Importance: 1

Used for:

- Rescue card illustration
- Illustration and additional pages of the rescue card
- Guide for emergency personnel, section 3

## 10. Explanation of pictograms used

### Other vehicle-related pictograms



#### High-voltage cable

Identifies a high-voltage cable.

It should be possible to distinguish high-voltage components from the high-voltage battery. The key and the pictogram graphics should match each other with regard to the line concept used for the frames.

Importance: 1

Used for:

- Rescue card illustration
- Illustration and additional pages of the rescue card



#### Diesel fuel tank capacity

Indicates the tank capacity with a defined colour.

Importance: 1

Used for:

- Rescue card illustration
- Additional pages of the rescue card, section 5
- Guide for emergency personnel, section 5



#### Petrol/ethanol fuel tank capacity

Indicates the tank capacity with a defined colour.

Importance: 1

Used for:

- Rescue card illustration
- Additional pages of the rescue card, section 5
- Guide for emergency personnel, section 5

### Other vehicle-related pictograms



#### Gas tank and type of gas (CNG)

Indicates the tank capacity with a defined colour and names the type of gas.

Importance: 1

Used for:

- Rescue card illustration
- Additional pages of the rescue card, section 3
- Guide for emergency personnel, section 3



#### Manual gas shut-off valve and type of gas (CNG)

Indicates the manual gas shut-off valve with a defined colour and names the type of gas.

Importance: 1

Used for:

- Rescue card illustration
- Additional pages of the rescue card, section 3
- Guide for emergency personnel, section 3



## 10. Explanation of pictograms used

### Other vehicle-related pictograms



#### Automatic gas safety valve and type of gas (CNG)

Indicates the device that controls gas overpressure in a tank with a defined colour and names the type of gas.

- Pressure-controlled (pressure relief device)
- Temperature-controlled (temperature-controlled pressure relief device)

Importance: 1

Used for:

- Rescue card illustration
- Additional pages of the rescue card, section 3
- Guide for emergency personnel, section 5



#### Gas tank and type of gas (LPG)

Indicates the tank capacity with a defined colour and names the type of gas.

Importance: 1

Used for:

- Rescue card illustration
- Additional pages of the rescue card, section 3
- Guide for emergency personnel, section 3

### Other vehicle-related pictograms



#### Manual gas shut-off valve and type of gas (LPG)

Indicates the manual gas shut-off valve with a defined colour and names the type of gas.

Importance: 1

Used for:

- Rescue card illustration
- Additional pages of the rescue card, section 3
- Guide for emergency personnel, section 3



#### Automatic gas safety valve and type of gas (LPG)

Indicates the device that controls gas overpressure in a tank with a defined colour and names the type of gas.

- Pressure-controlled (pressure relief device)
- Temperature-controlled (temperature-controlled pressure relief device)

Importance: 1

Used for:

- Rescue card illustration
- Additional pages of the rescue card, section 3
- Guide for emergency personnel, section 5



#### Gas pipe (general)

Identifies a gas pipe with a defined colour.

Importance: 1

Used for:

- Rescue card illustration
- Guide for emergency personnel, section 5

## 10. Explanation of pictograms used

### Other vehicle-related pictograms

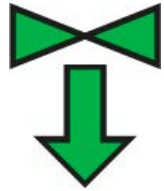

#### Direction of the gas safety valve (e.g. LPG) in the vehicle

Indicates the direction of the gas safety valve in an illustration with a defined colour.

Importance: 1

Used for:

- Rescue card illustration



#### Compressed air tanks

Identifies a compressed air tank.

Importance: 1

Used for:

- Rescue card illustration
- Guide for emergency personnel, section 5



#### Air conditioning component

Identifies an air conditioning component with a defined colour.

The coolant must be specified on the additional pages and the rescue card (e.g. CO<sub>2</sub> fluorocarbon basis). If there is not enough space, the snowflake may be omitted.

Importance: 1

Used for:

- Rescue card illustration
- Additional pages of the rescue card, section 5
- Guide for emergency personnel, section 5

### Other vehicle-related pictograms



#### Air conditioning pipe

Identifies a gas pipe with a defined colour.

The type or designation of the coolant must be identified (e.g. CO fluorocarbon basis).

Importance: 1

Used for:

- Rescue card illustration
- Guide for emergency personnel, section 5

### Pictograms related to fire fighting and safety



#### General warning sign

Indicates a general warning.

Importance: 1

Used for:

- Additional pages of the rescue card, corresponding sections as necessary
- Guide for emergency personnel, corresponding sections as necessary



#### Warning: electricity

Warns of electricity and dangerous voltage.

Importance: 1

Used for:

- Additional pages of the rescue card, corresponding sections as necessary
- Guide for emergency services

## 10. Explanation of pictograms used

### Pictograms related to fire fighting and safety



#### Warning, low temperature

Indicates hazards caused by low temperatures, e.g. frostbite from cold gases (e.g. LNG, air conditioning gas).

Importance: 1

Used for:

- Additional pages of the rescue card, sections 5, 6 and 8
- Guide for emergency personnel, sections 5, 6, 8 and 9

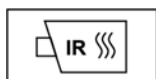

#### Use thermal infrared camera

Indicates that a thermal infrared camera should be used to detect a fire.

Importance: 2

Used for:

- Additional pages of the rescue card, section 6
- Guide for emergency personnel, section 6



#### Automatic fire extinguisher system

Indicates that the vehicle has an automatic fire extinguisher system.

Importance: 1

Used for:

- Rescue card illustration
- Additional pages of the rescue card, section 6
- Guide for emergency personnel, section 6

### Pictograms related to fire fighting and safety



#### Special access to battery

Special access through which water can be poured into the high-voltage battery of an electric vehicle.

Importance: 1

Used for:

- Additional pages of the rescue card, section 6
- Guide for emergency personnel, section 6



#### Extinguish fire with water

Indicates that a fire must be extinguished with water.

Importance: 1

Used for:

- Additional pages of the rescue card, section 6
- Guide for emergency personnel, section 6



#### Extinguish fire with wet compressed air foam (CAF)

Indicates that a fire must be extinguished with wet compressed air foam. System in which foam and air are constantly mixed under pressure with the water from the fire extinguishing centrifugal pump (CAFS). When using wet compressed air foam, the nominal ratio of foam to air volume is 1:3 to 1:10 for mixture in the CAFS.

Importance: 1

Used for:

- Additional pages of the rescue card, section 6
- Guide for emergency personnel, section 6

## 10. Explanation of pictograms used

### Pictograms related to fire fighting and safety



#### Extinguish fire with dry compressed air foam

Indicates that a fire must be extinguished with dry compressed air foam. System in which foam and air are constantly mixed under pressure with the water from the fire extinguishing centrifugal pump (CAFS). When using dry compressed air foam, the nominal ratio of foam to air volume is more than 1:10 for mixture in the CAFS.

Importance: 1

Used for:

- Additional pages of the rescue card, section 6
- Guide for emergency personnel, section 6



#### Extinguish fire with ABC powder

Indicates that a fire must be extinguished with ABC powder.

Importance: 1

Used for:

- Additional pages of the rescue card, section 6
- Guide for emergency personnel, section 6



#### Do not extinguish with water

Prohibits the use of water to extinguish a fire.

Importance: 1

Used for:

- Additional pages of the rescue card, section 6
- Guide for emergency personnel, section 6

### Globally harmonised symbols



#### Explosive

Indicates the risk of explosion.

Importance: 1

Used for:

- Additional pages of the rescue card, sections 5, 6, 8 and 9
- Guide for emergency personnel, sections 5, 6, 8 and 9



#### Flammable

Indicates danger due to flammability.

Importance: 1

Used for:

- Additional pages of the rescue card, sections 5, 6, 8 and 9
- Guide for emergency personnel, sections 5, 6, 8 and 9



#### Pressurised gases

Indicates danger due to pressurised gases.

Importance: 1

Used for:

- Additional pages of the rescue card, sections 5, 6, 8 and 9
- Guide for emergency personnel, sections 5, 6, 8 and 9

## 10. Explanation of pictograms used

### Globally harmonised symbols



#### Oxidising

Indicates danger due to substances that intensify fire.

Importance: 1

Used for:

- Additional pages of the rescue card, sections 5, 6, 8 and 9
- Guide for emergency personnel, sections 5, 6, 8 and 9



#### Corrosive

Indicates danger due to corrosive substances.

Importance: 1

Used for:

- Additional pages of the rescue card, sections 5, 6, 8 and 9
- Guide for emergency personnel, sections 5, 6, 8 and 9



#### Health hazard

Indicates a hazard to human health.

Importance: 1

Used for:

- Additional pages of the rescue card, sections 5, 6, 8 and 9
- Guide for emergency personnel, sections 5, 6, 8 and 9

### Globally harmonised symbols



#### Toxic

Indicates danger due to acute toxicity.

Importance: 1

Used for:

- Additional pages of the rescue card, sections 5, 6, 8 and 9
- Guide for emergency personnel, sections 5, 6, 8 and 9



#### Environmental hazard

Indicates the risk of endangering the environment.

Importance: 1

Used for:

- Additional pages of the rescue card, sections 5, 6, 8 and 9
- Guide for emergency personnel, sections 5, 6, 8 and 9

---

**Symbols used in this guide**



**Warning: potentially explosive materials**

ISO 7010



**Information**

General information